

Nº PLANO: 1.1	TÍTULO DEL PLANO: SITUACIÓN Y EMPLAZAMIENTO	FIC: SAN JUAN ARQUITECTURA S.L.
ESCALA: DIN A1: 1/1000 DIN A3: 1/2000	FECHA: MARZO 2018	FIC: SCma INGENIERIA Y MEDIOAMBIENTE

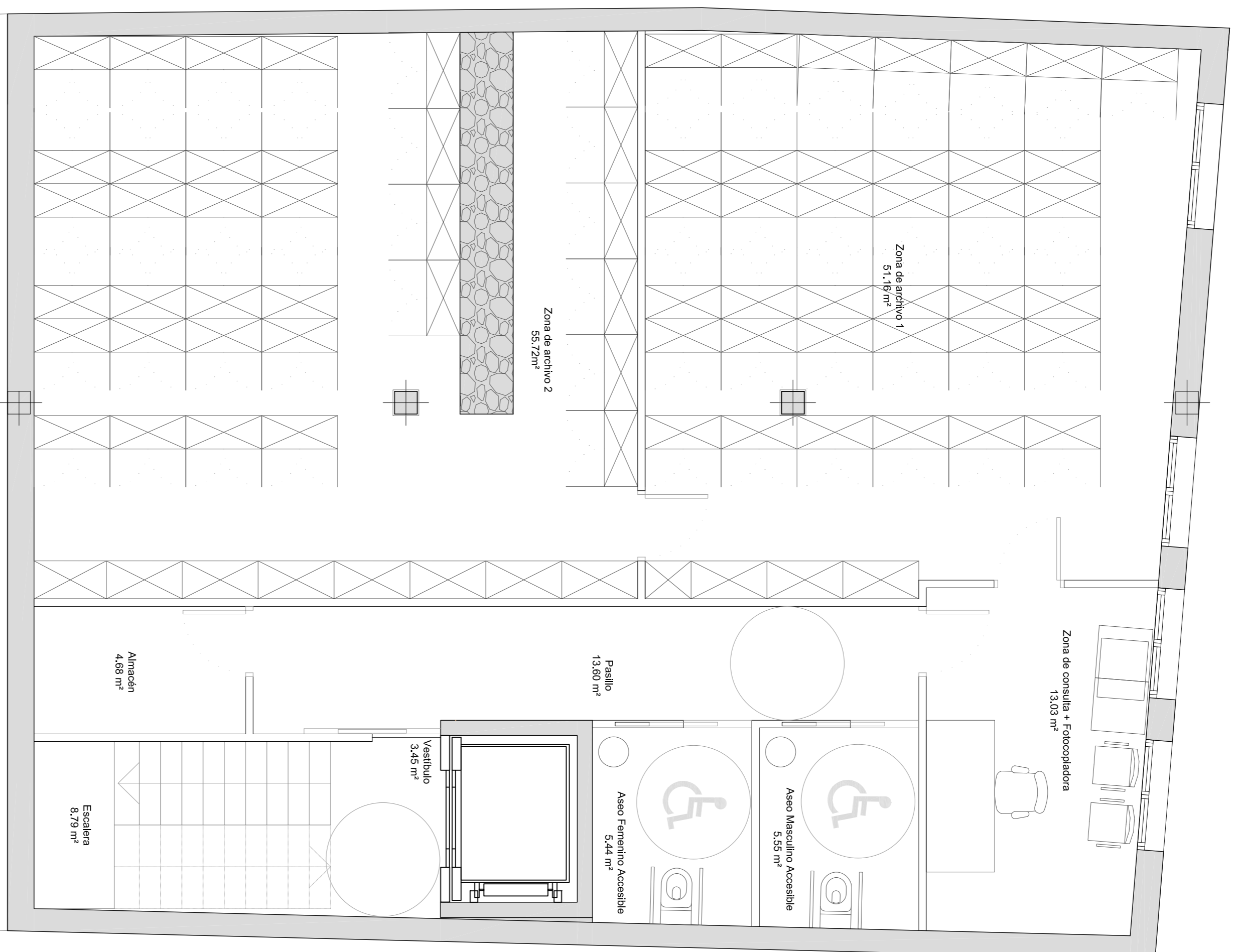

PLANTA SÓTANO

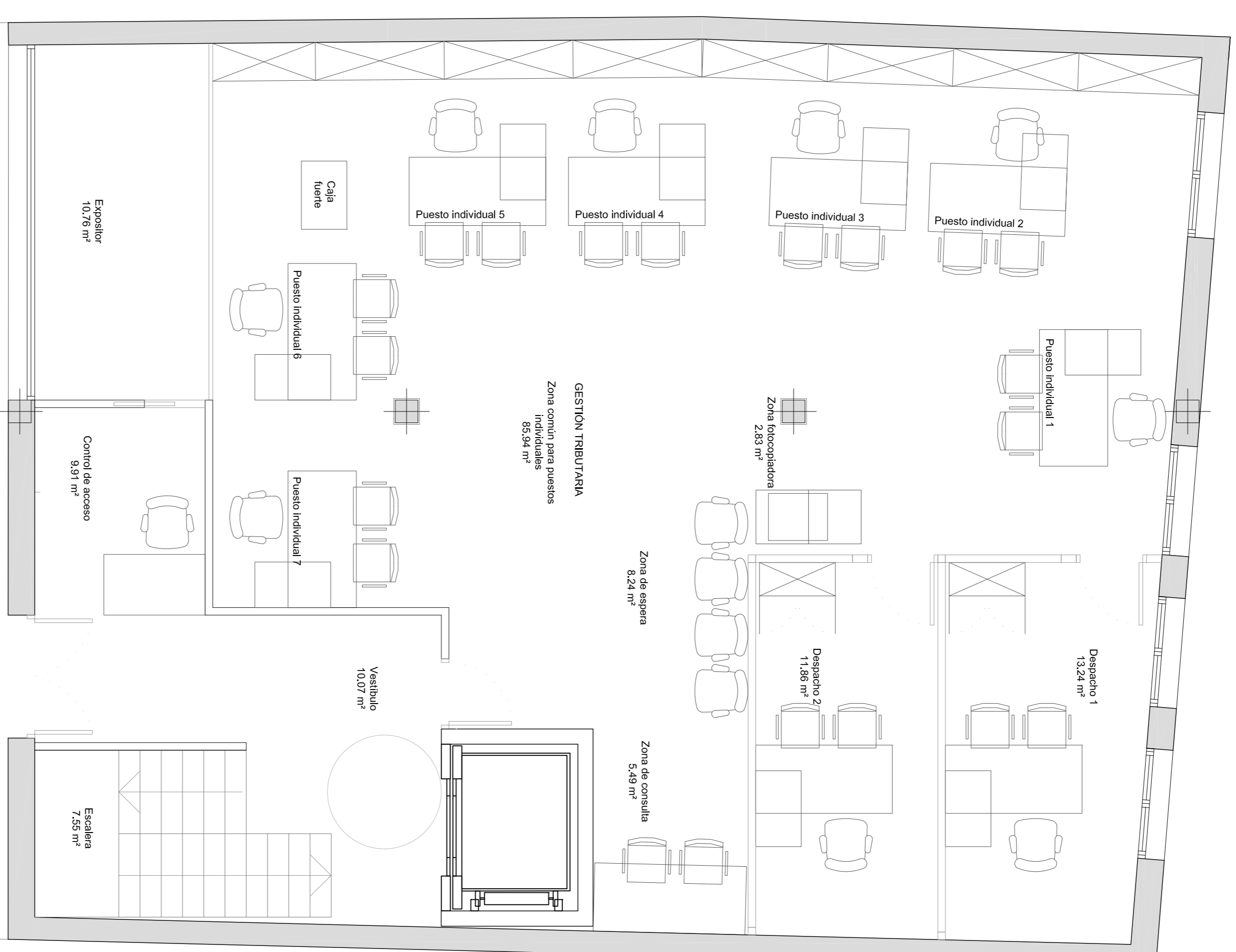

PLANTA BAJA

PROYECTO PARA INSTALACIONES DEL AREA ECONOMICA Y ARCHIVO MUNICIPAL DEL AYUNTAMIENTO DE ARANDA DE DUERO

EQUIPO REDACTOR:

SAN JUAN ARQUITECTURA S.L. SCma

GRAN VÍA ROMÁN Y CALLE 51 - 4 - VALENCIA | TIF: 963900739 | FAX: 963900088 | sanjuan@sanjuanarquitectura.com | WWW.SANJUANARQUITECTURA.COM | INGENIERÍA Y MEDIOAMBIENTE

Nº PLANO:
2.1

TÍTULO DEL PLANO:
DISTRIBUCIÓN
P. SÓTANO Y P.BAJA

FIC: SAN JUAN ARQUITECTURA S.L.

ESCALA:
DIN A1: 1/50
DIN A3: 1/100

FECHA:
MARZO 2018

FIC: SCma INGENIERÍA Y MEDIOAMBIENTE

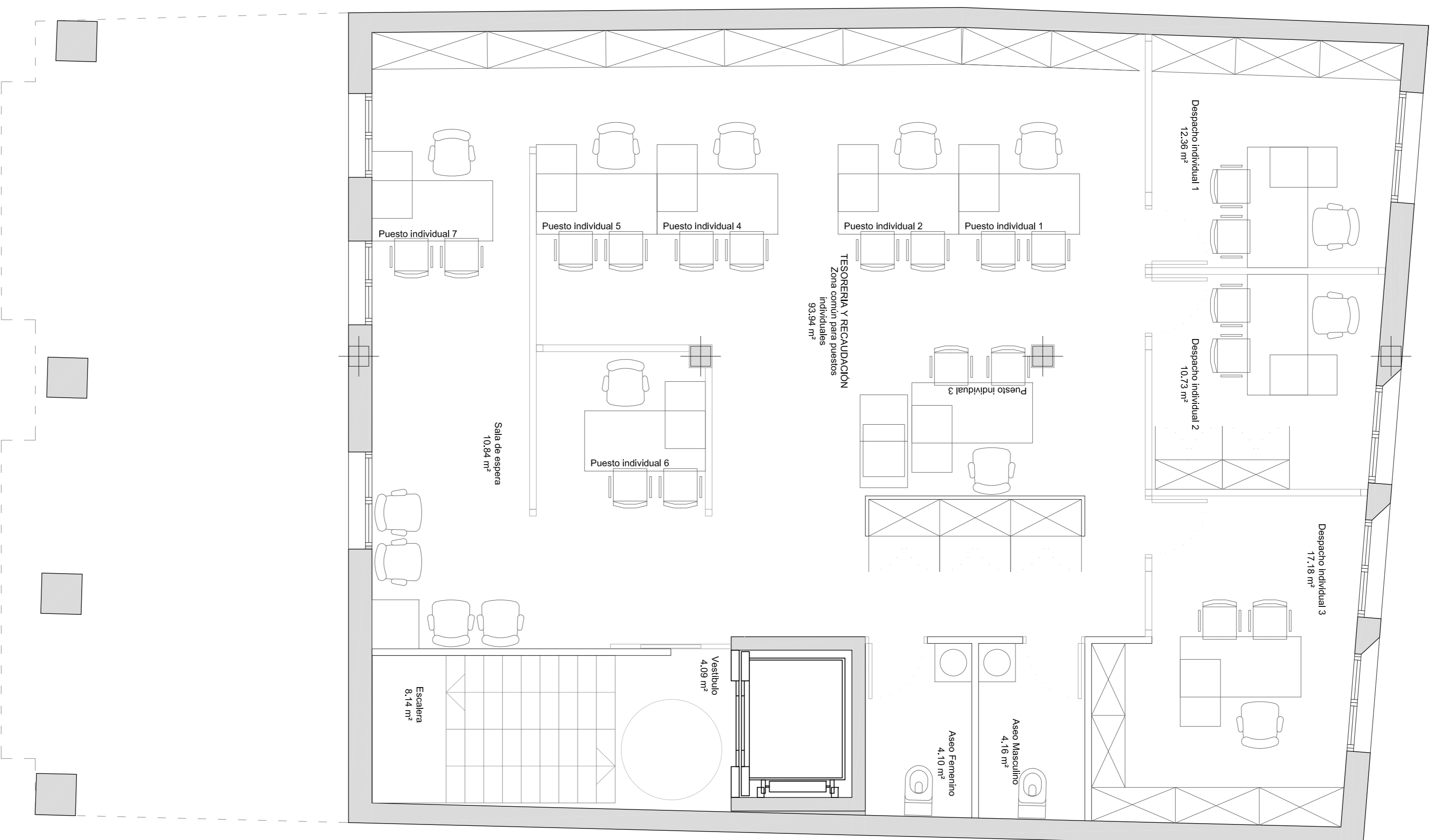

PLANTA PRIMERA

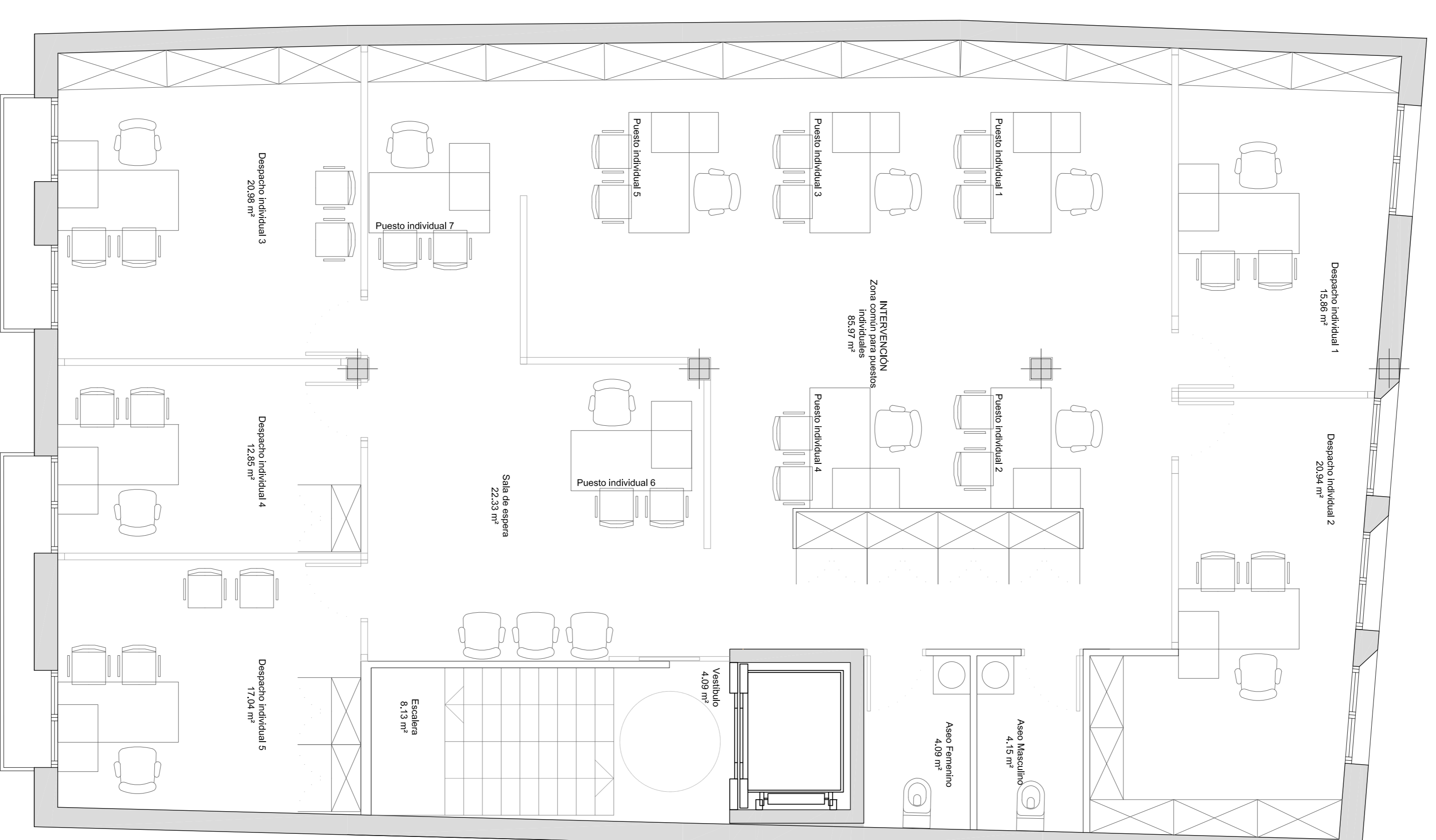

PLANTA SEGUNDA

EQUIPO REDACTOR:

SAN JUAN ARQUITECTURA S.L. SCma

GRAN VÍA ROMÁN Y CALLE 53 s/n - 4.ª VIVIENDA | T.º 963900739 | FAX: 963900088 | sanjuan@sanjuanarquitectura.com | WWW.SANJUANARQUITECTURA.COM | INGENIERÍA Y MEDIOAMBIENTE

Nº PLANO:
2.2

ESCALA:
DIN A1: 1/50
DIN A3: 1/100

TÍTULO DEL PLANO:
DISTRIBUCIÓN
P. PRIMERA Y P. SEGUNDA

FECHA:
MARZO 2018

FIC: SAN JUAN ARQUITECTURA S.L.

FIC: SCma INGENIERÍA Y MEDIOAMBIENTE

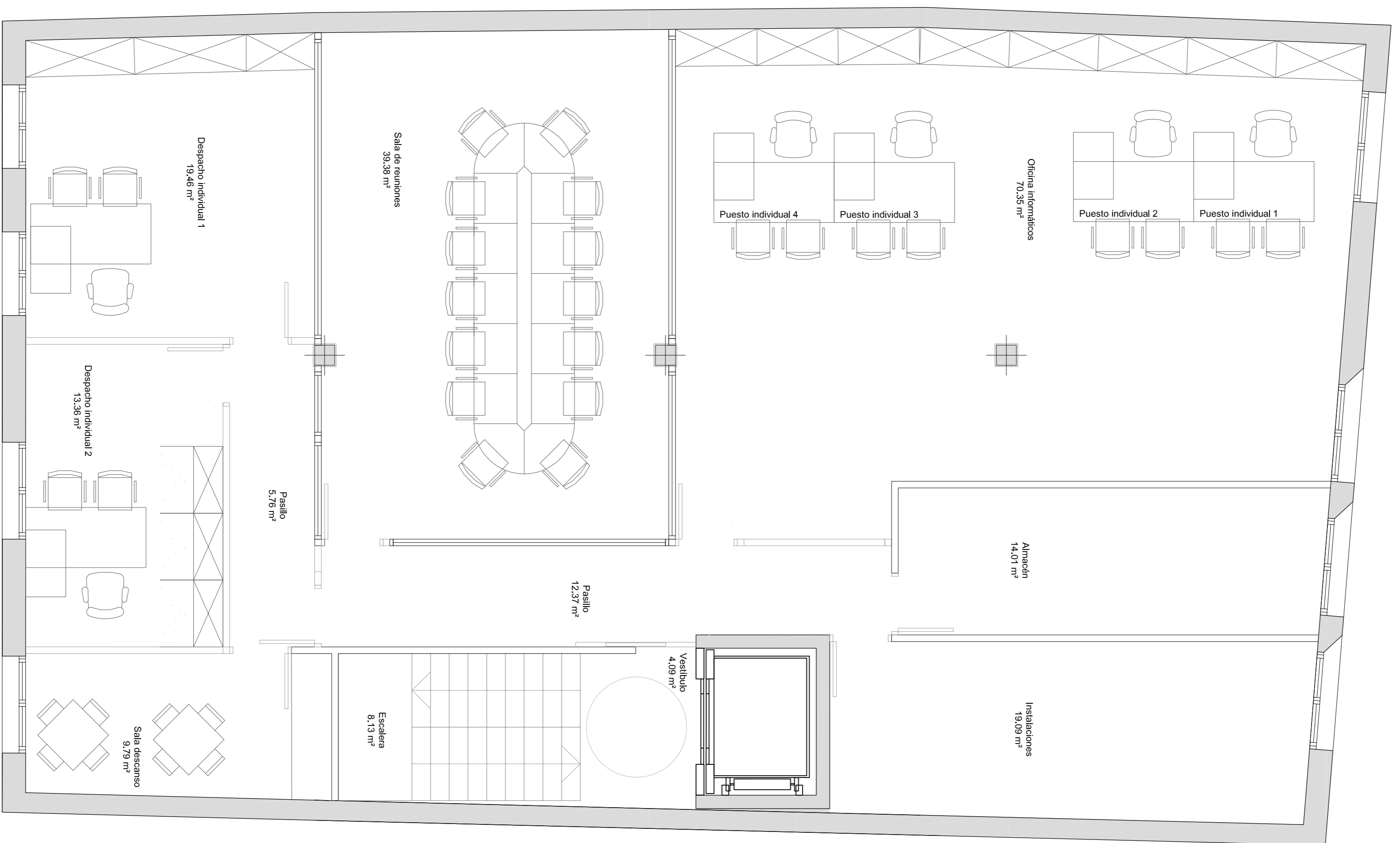

PLANTA BAJO CUBIERTA



PLANTA CUBIERTA

Nº PLANO: 2.3	TÍTULO DEL PLANO: DISTRIBUCIÓN P. BAJO CUBIERTA Y P CUBIERTA	FIC: SAN JUAN ARQUITECTURA S.L.
ESCALA: DIN A1: 1/50 DIN A3: 1/100	FECHA: MARZO 2018	FIC: SCma INGENIERIA Y MEDIOAMBIENTE

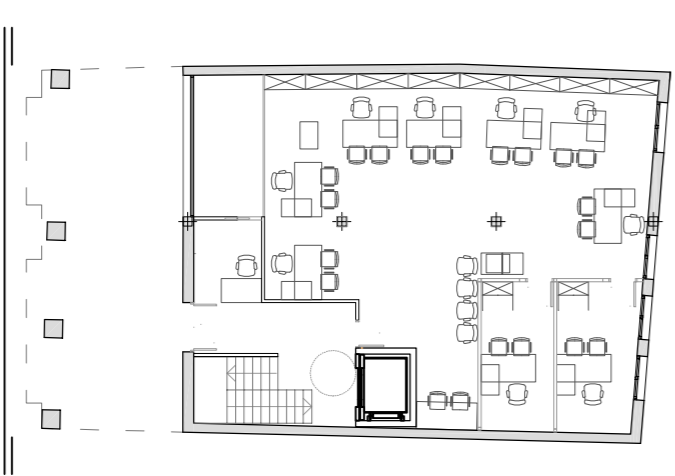

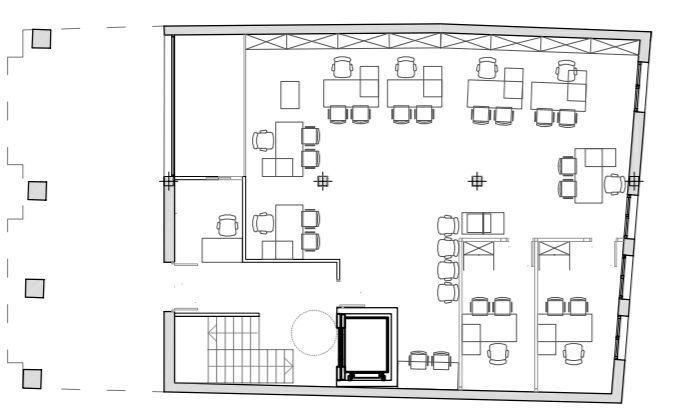
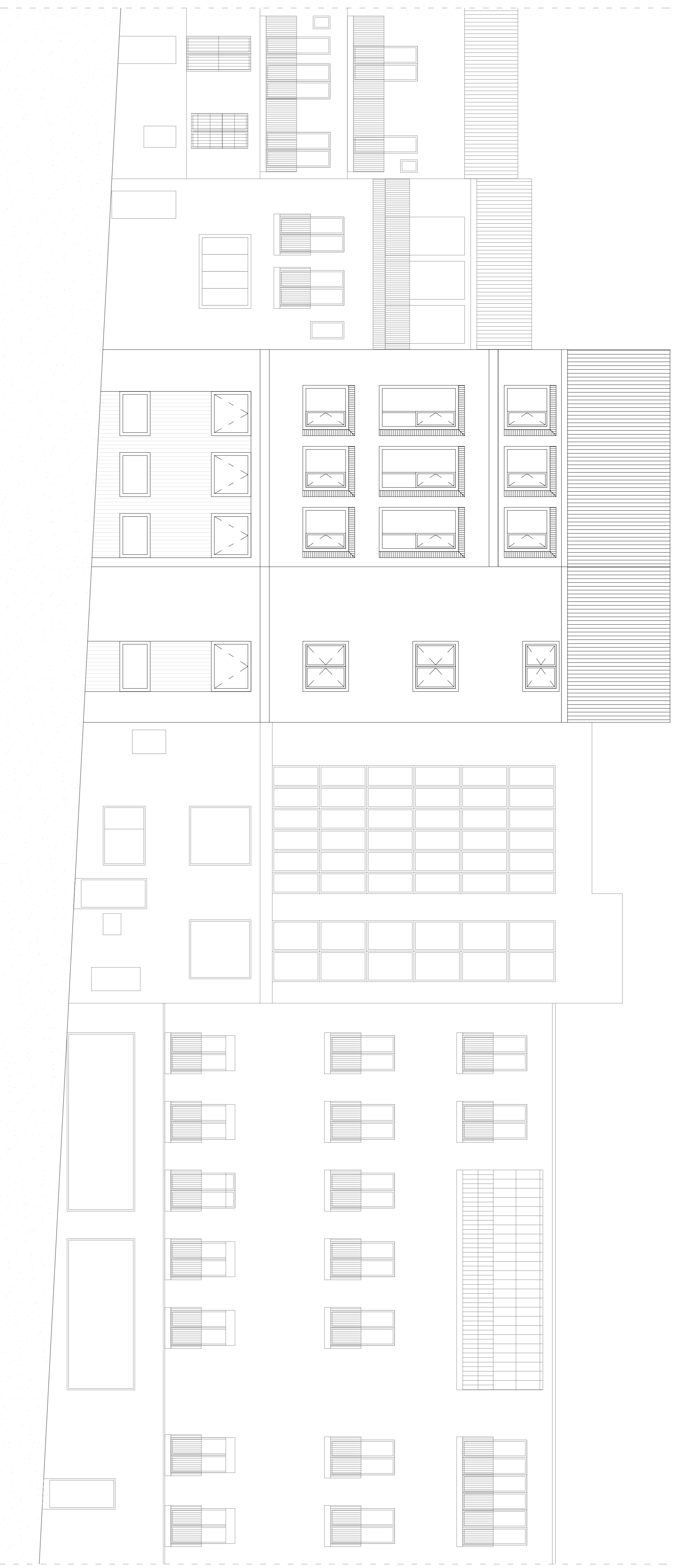

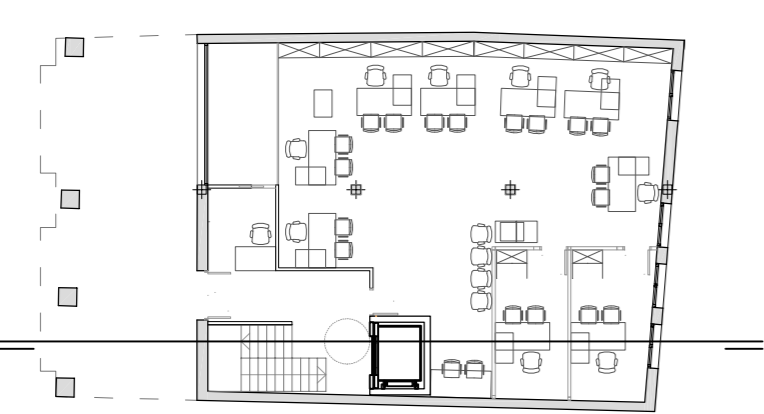
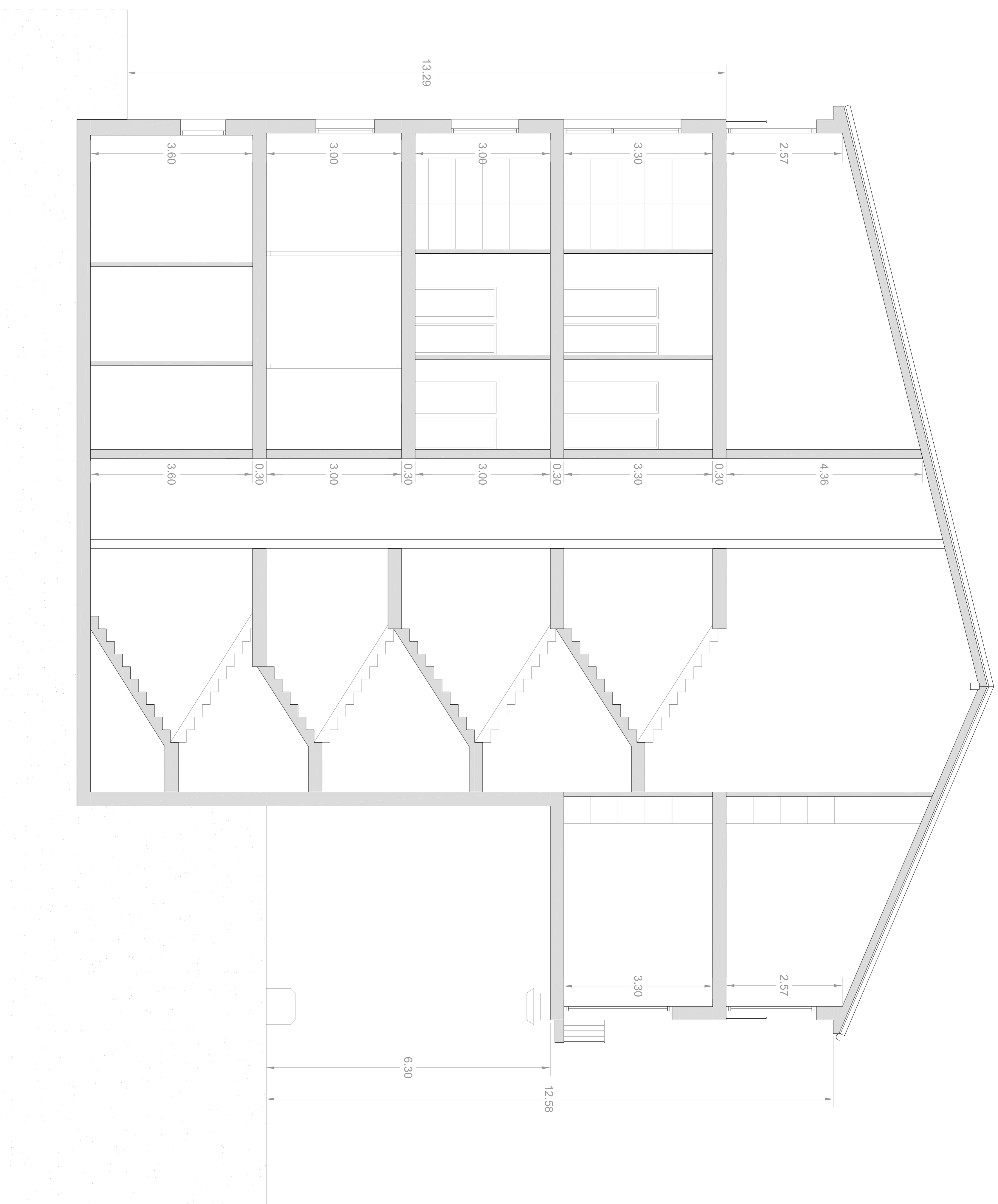

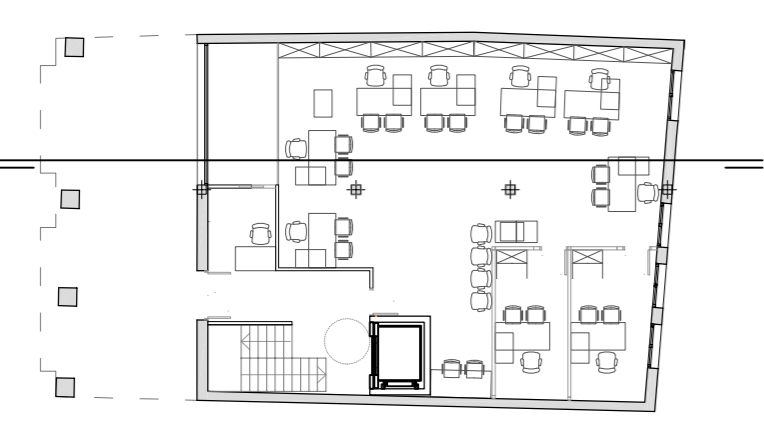
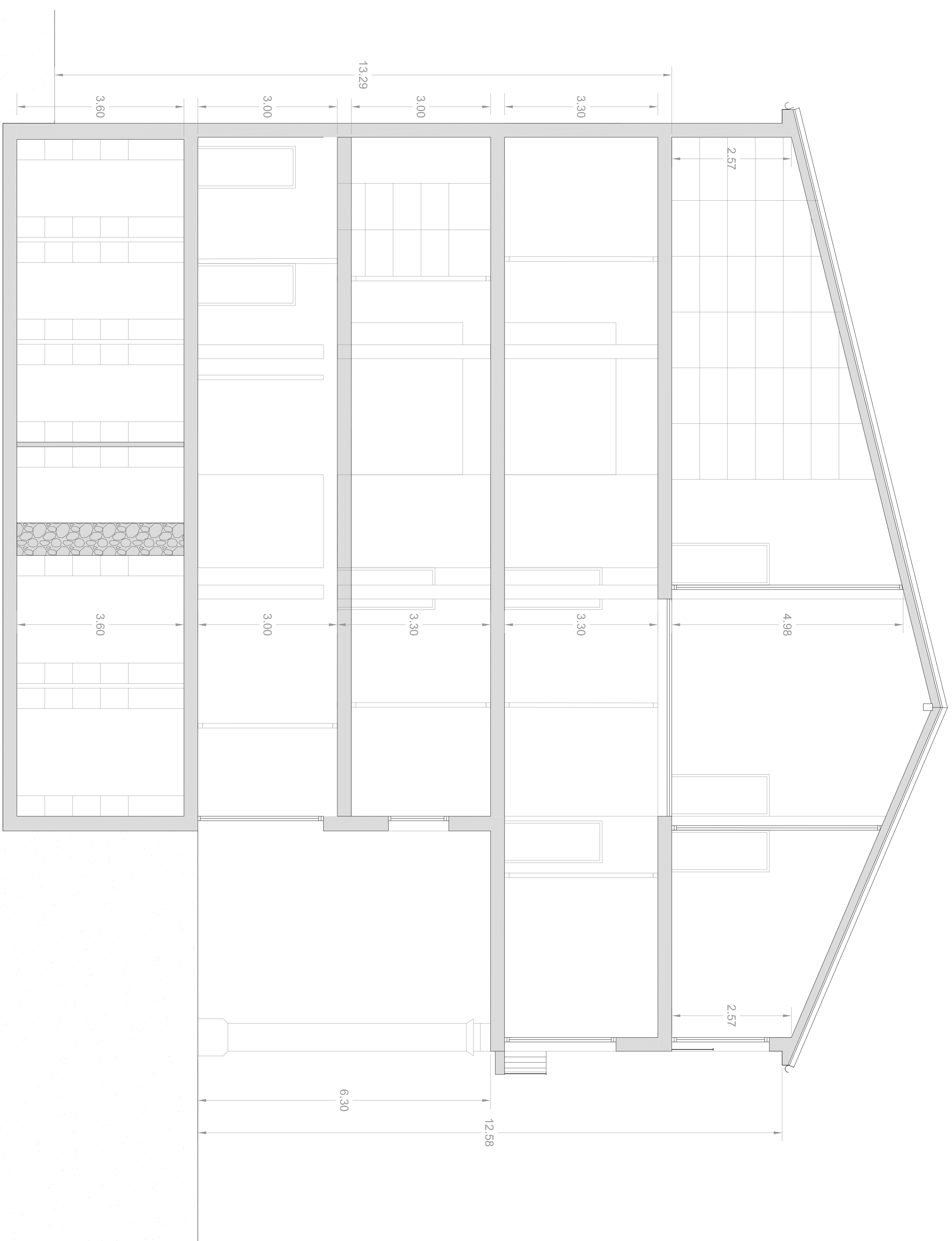

PROMOTOR:  AYUNTAMIENTO DE ARANDA DE DUERO	PROYECTO PARA INSTALACIONES DEL AREA ECONOMICA Y ARCHIVO MUNICIPAL DEL AYUNTAMIENTO DE ARANDA DE DUERO	EQUIPO REDACTOR: SAN JUAN ARQUITECTURA S.L. SCma <small>GRAN VÍA RAMÓN Y CAJAL, 53 - 4. VALÈNCIA. T.F. 963900729 F.AX. 963900806 Email: info@sanjuanarquitectura.com WWW.SANJUANARQUITECTURA.COM INGENIERIA Y MEDIOAMBIENTE</small>	Nº PLANO: 3.4 ESCALA: DIN A1: 1/50 DIN A3: 1/100	TÍTULO DEL PLANO: SECCION LONGITUDINAL 2 FECHA: MARZO 2018	FPO: SAN JUAN ARQUITECTURA S.L.  FPO: SCma INGENIERIA Y MEDIOAMBIENTE 
--	---	--	---	---	--

PLANTA SÓTANO

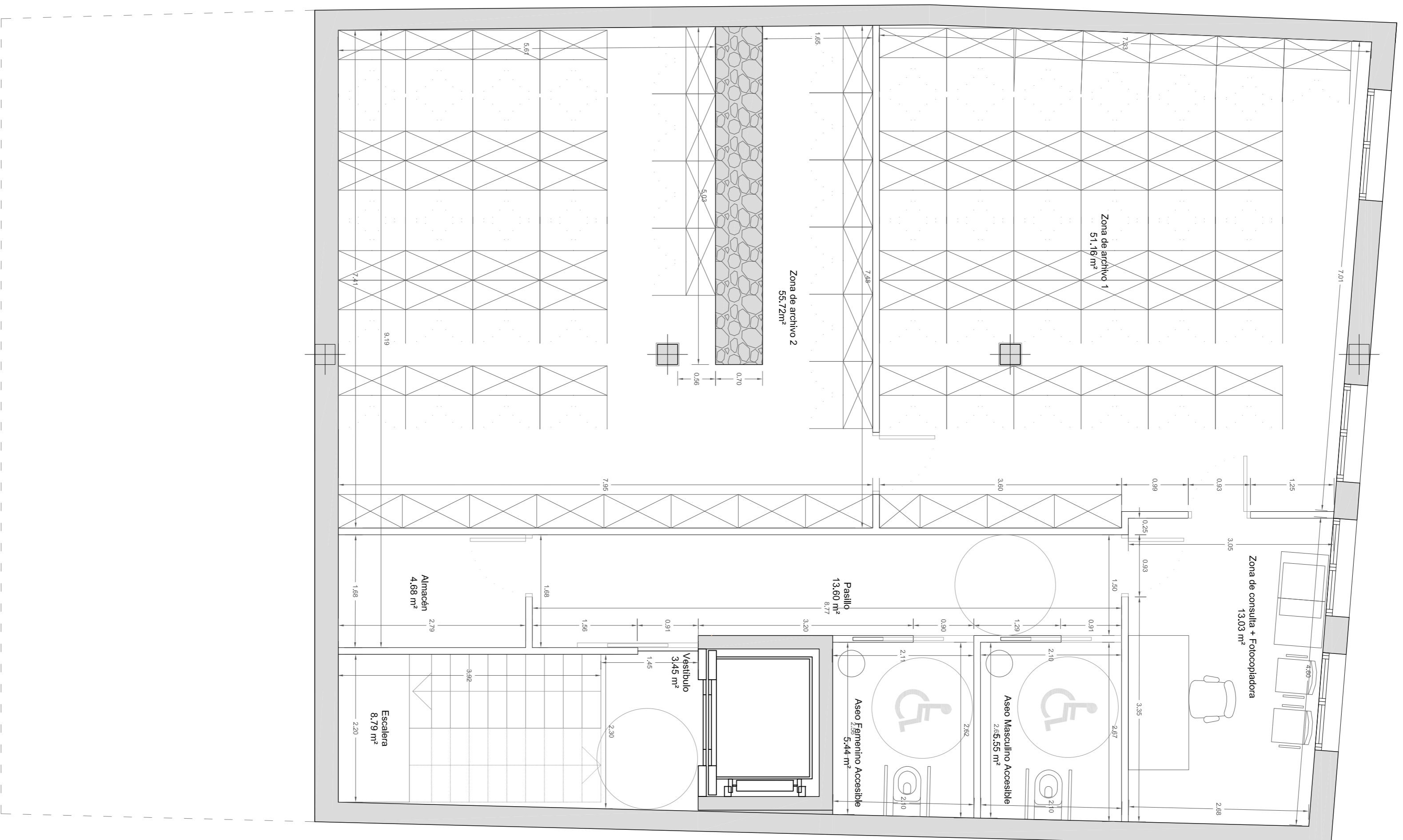

PLANTA BAJA

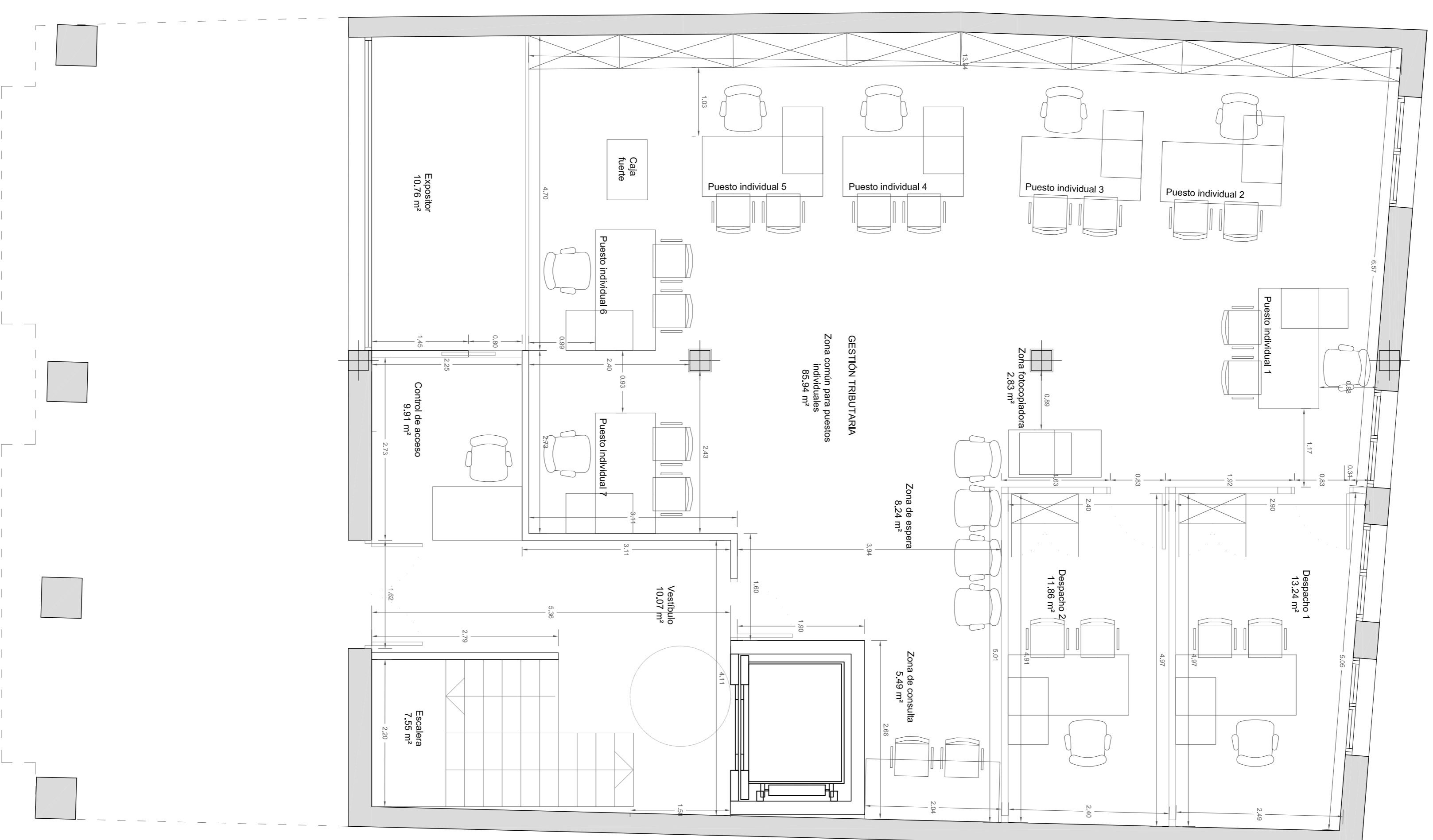

Nº PLANO:
4.1

TÍTULO DEL PLANO:
COTAS Y SUPERFICIES
P. BAJO CUBIERTA Y P. CUBIERTA

FOO: SAN JUAN ARQUITECTURA S.L.

ESCALA:
DIN A1: 1/50
DIN A3: 1/100

FECHA:
MARZO 2018

FOO: SCma INGENIERIA Y MEDIOAMBIENTE

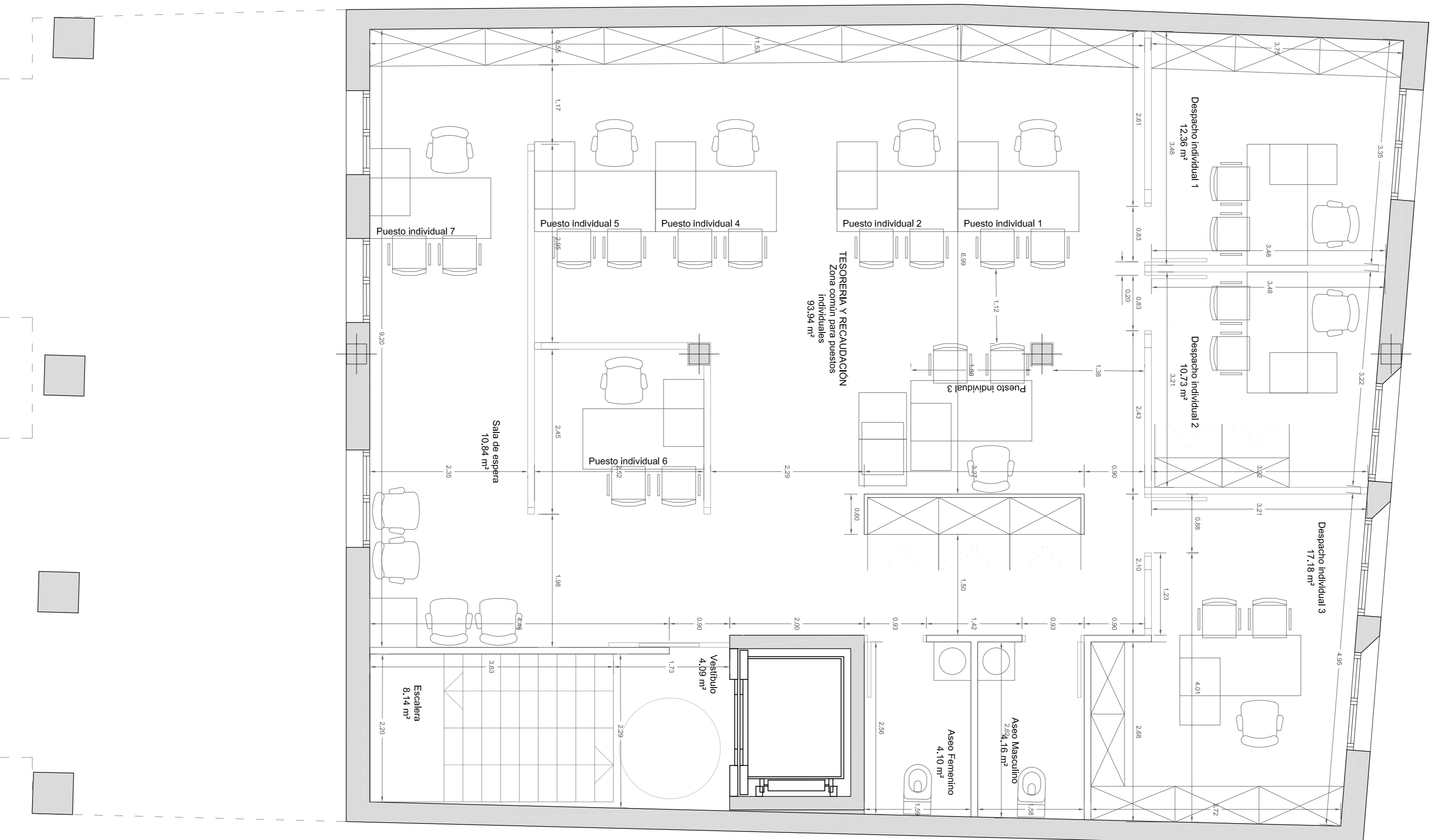

PLANTA PRIMERA

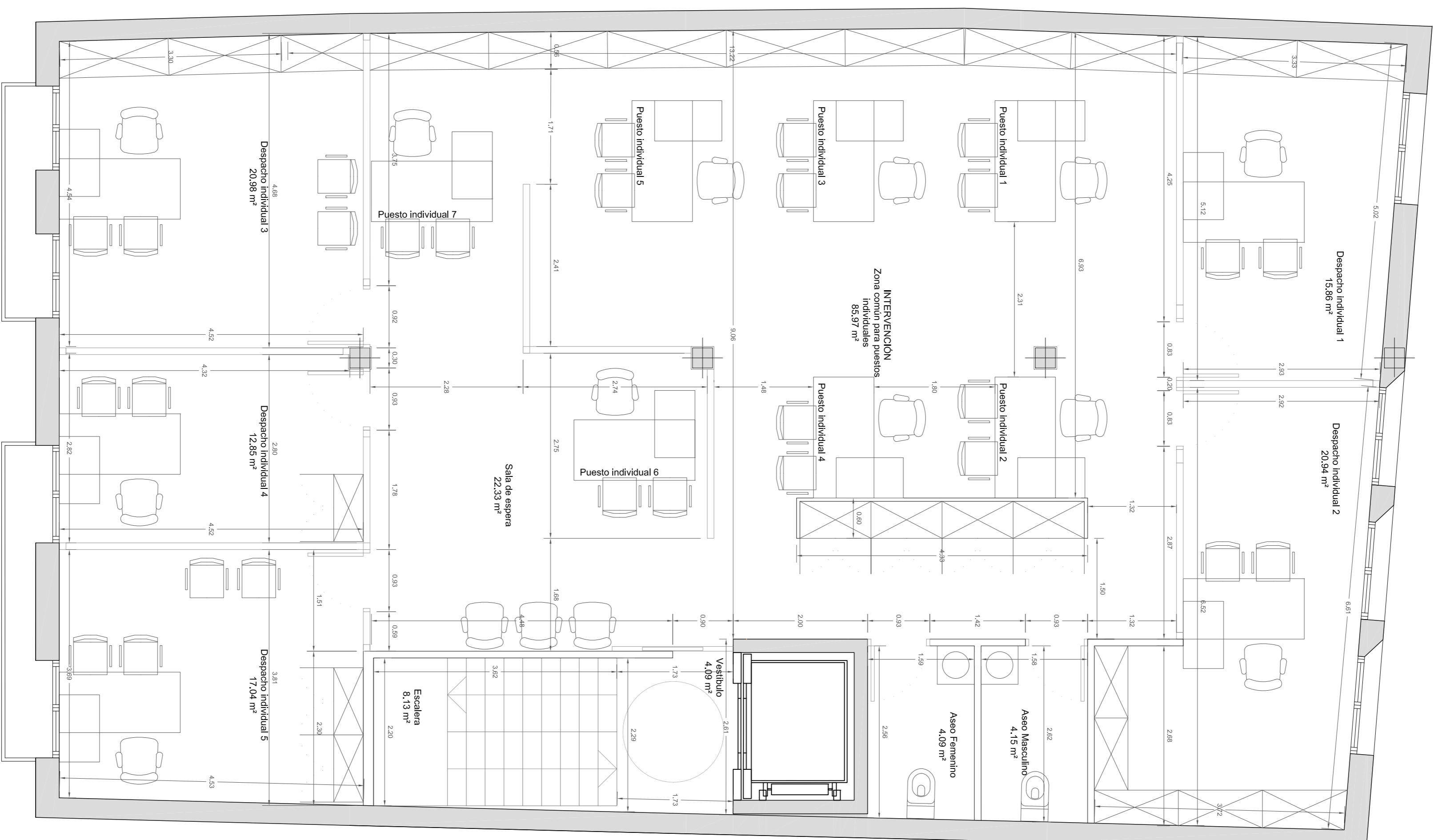

PLANTA SEGUNDA

EQUIPO REDACTOR:

SAN JUAN ARQUITECTURA S.L. SCma

GRAN VÍA RAMÓN Y CAJAL, 53 - 4. VALLEROLA. TIF: 963600739 | FAX: 963600061 | sanjuan@sanjuanarquitectura.com | WWW.SANJUANARQUITECTURA.COM | INGENIERÍA Y MEDIOAMBIENTE

Nº PLANO:
4.2

ESCALA:
DIN A1: 1/50
DIN A3: 1/100

TÍTULO DEL PLANO:
COTAS Y SUPERFICIES
P. PRIMERA Y P. SEGUNDA

FECHA:
MARZO 2018

FOC: SAN JUAN ARQUITECTURA S.L.

FOC: SCma INGENIERÍA Y MEDIOAMBIENTE

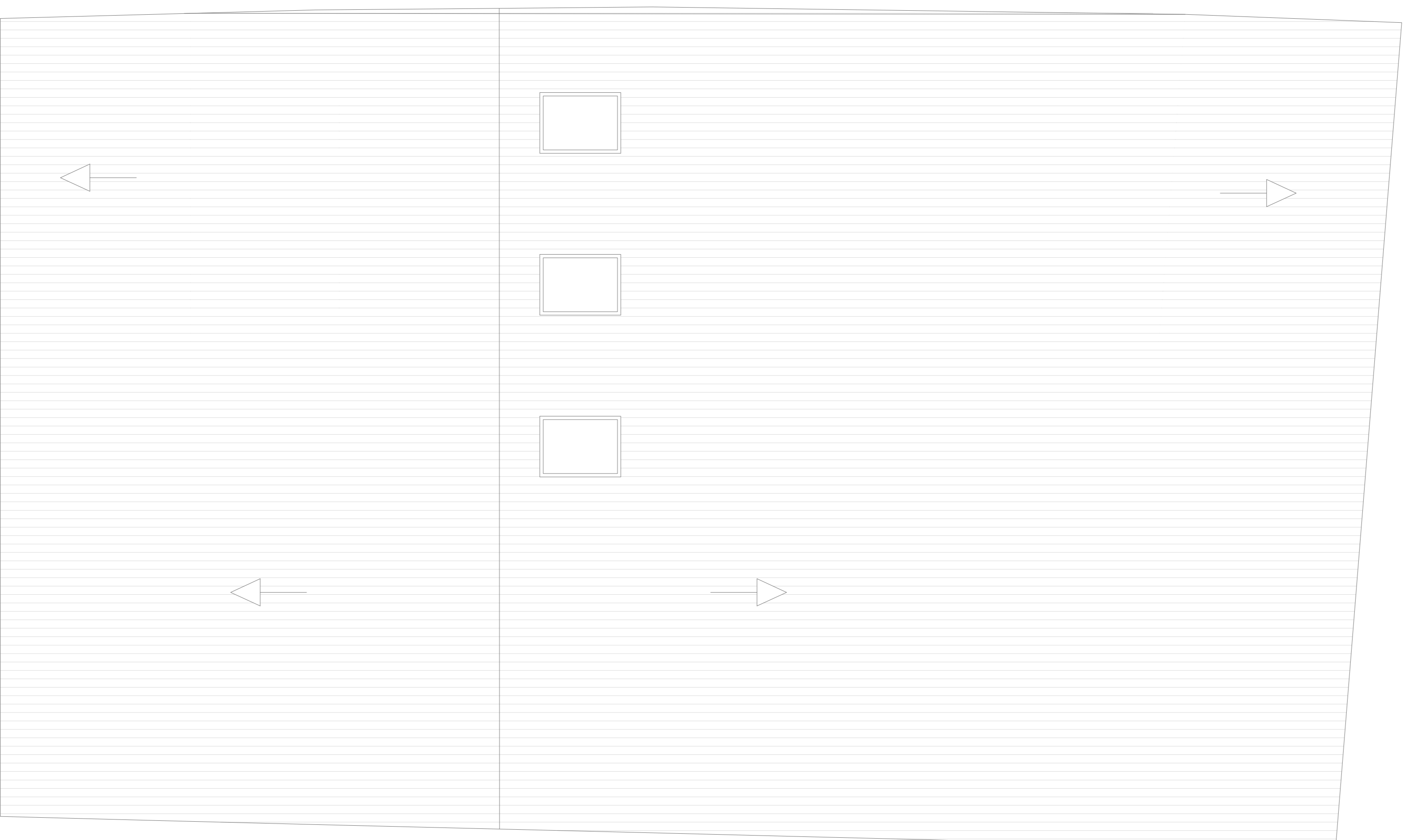
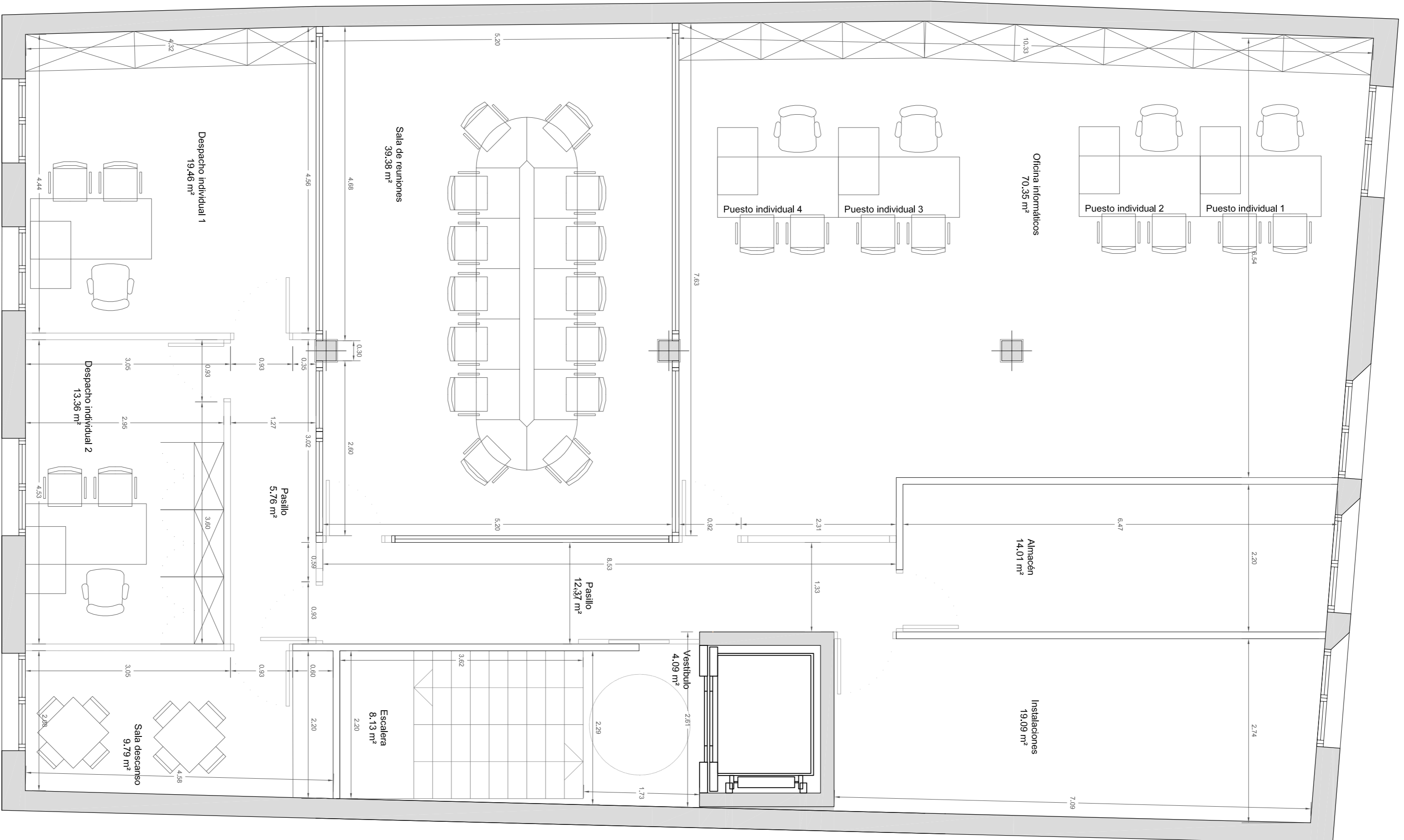

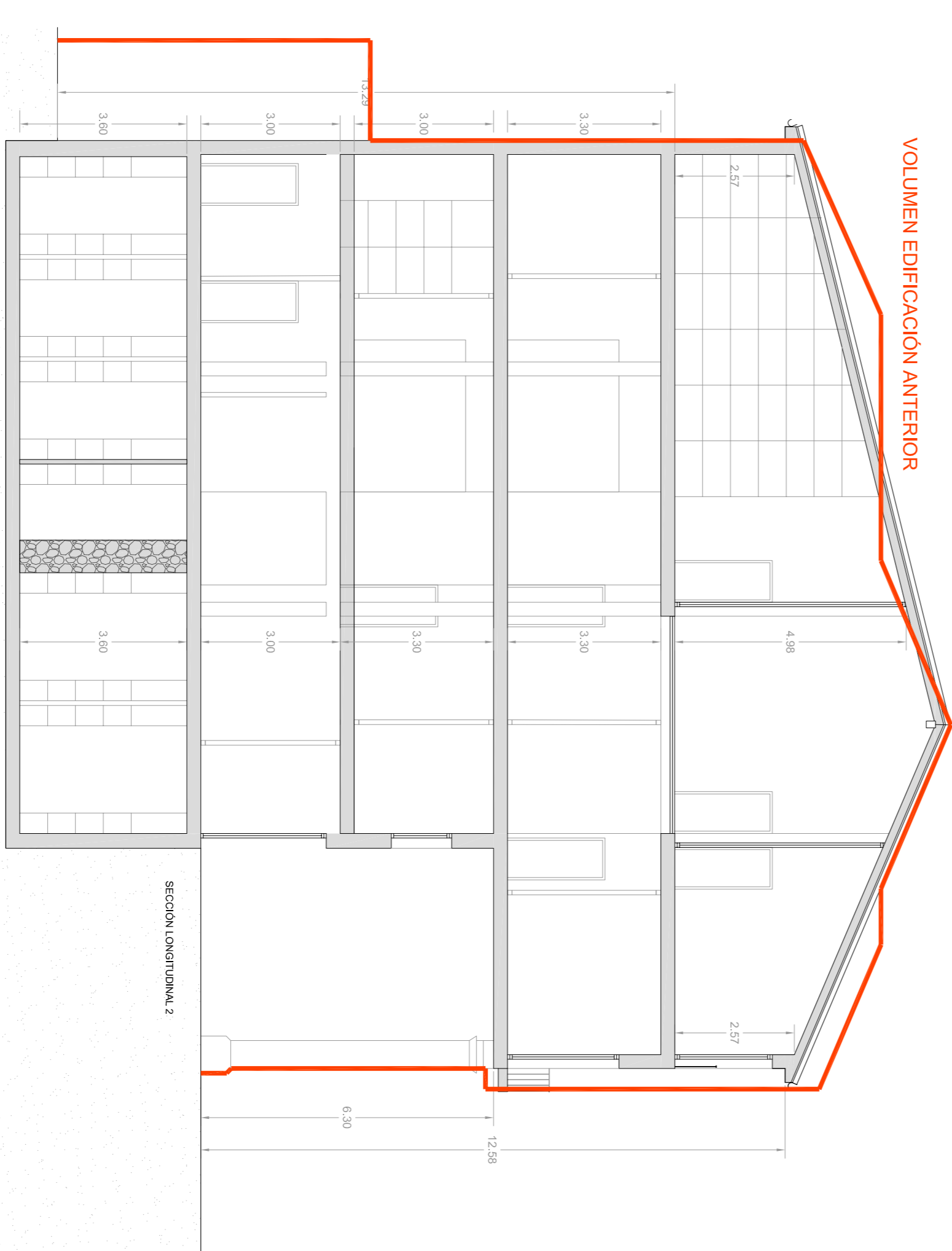
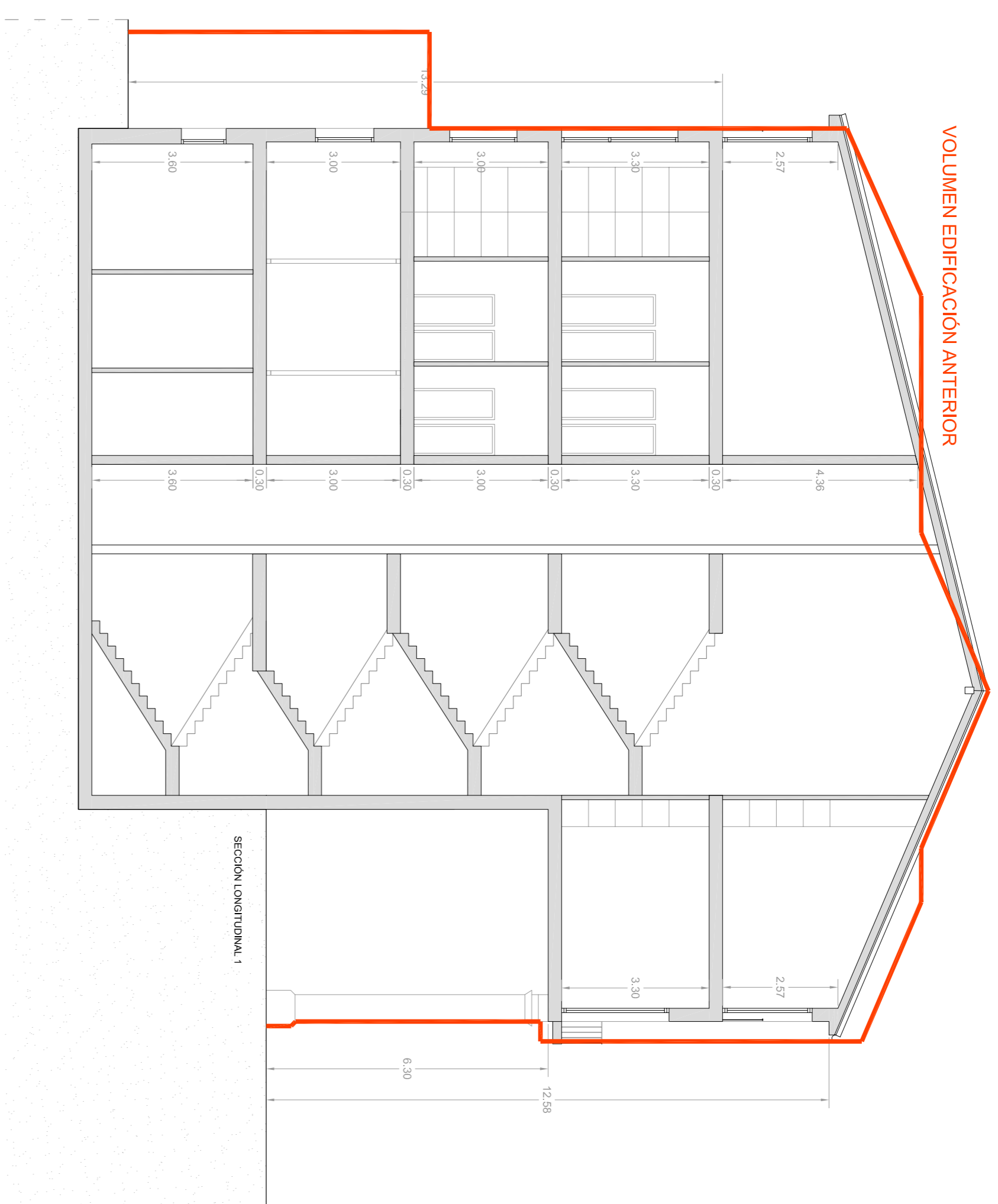
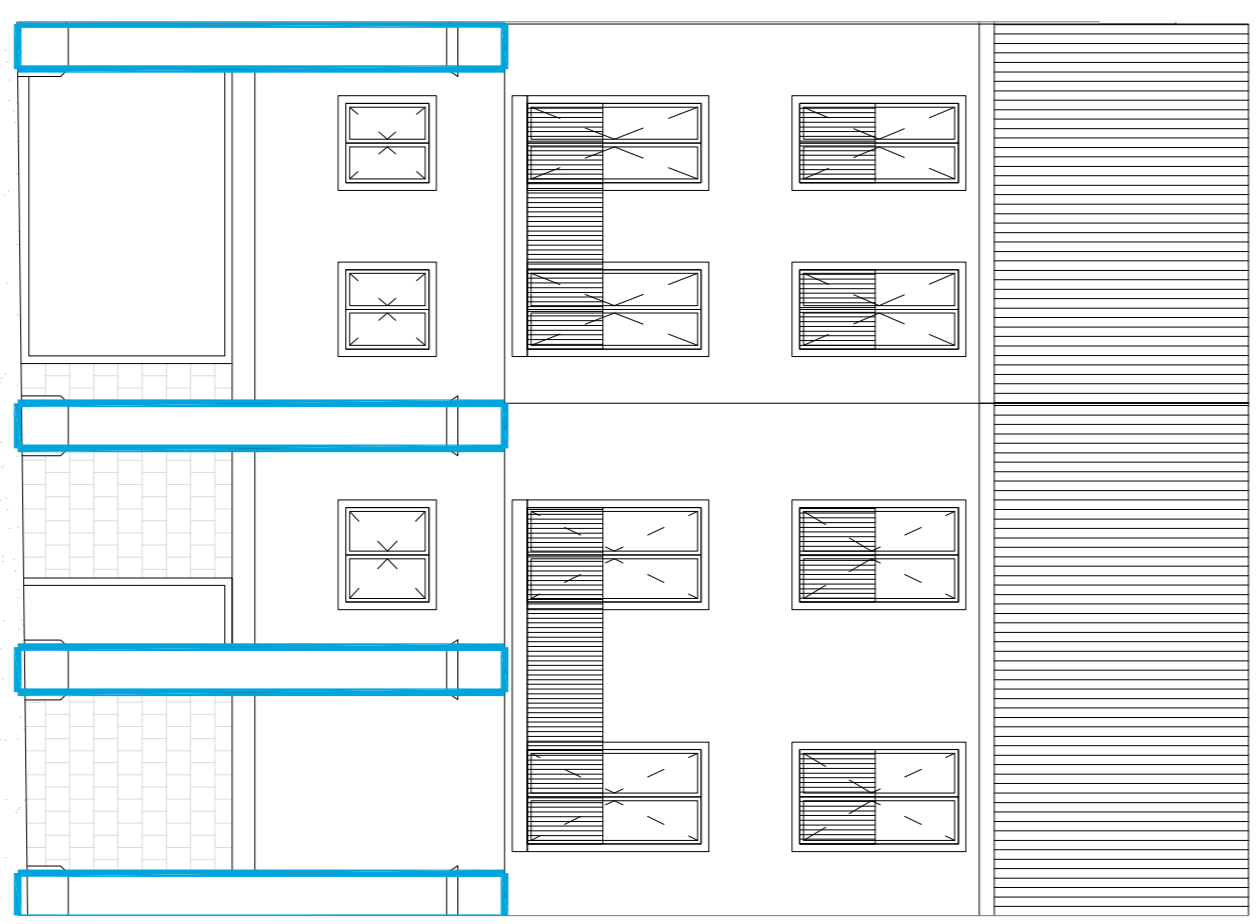
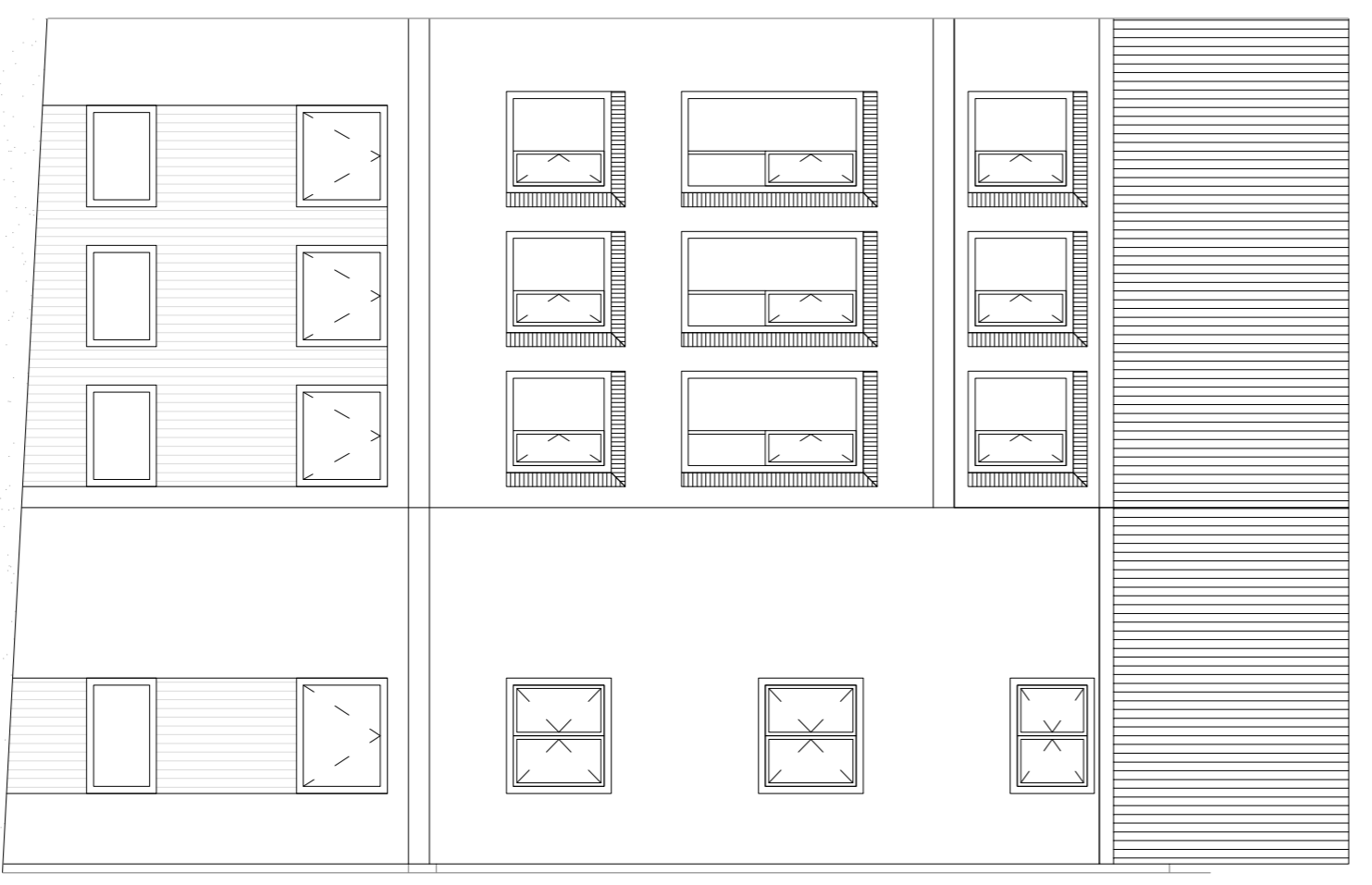
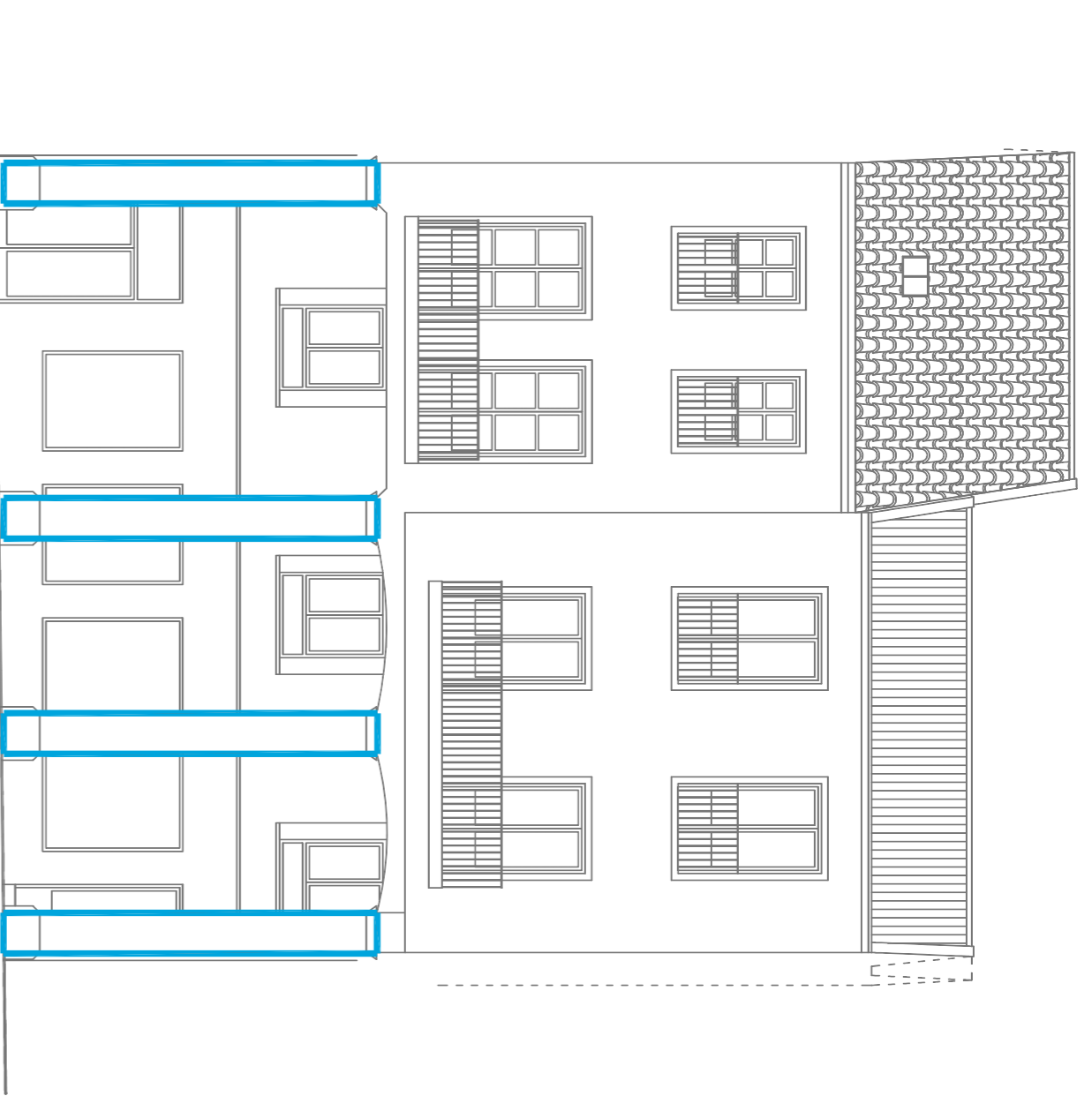
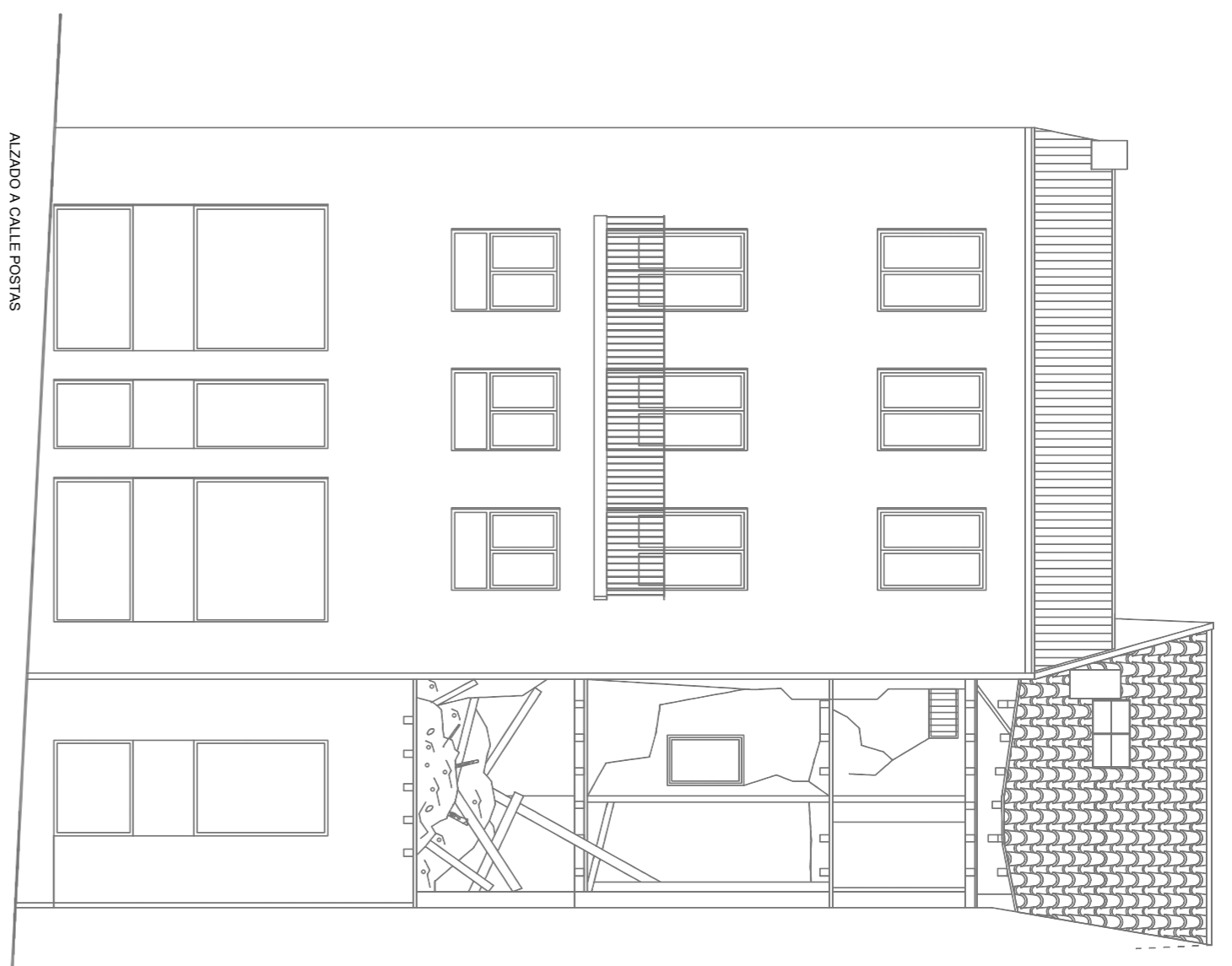



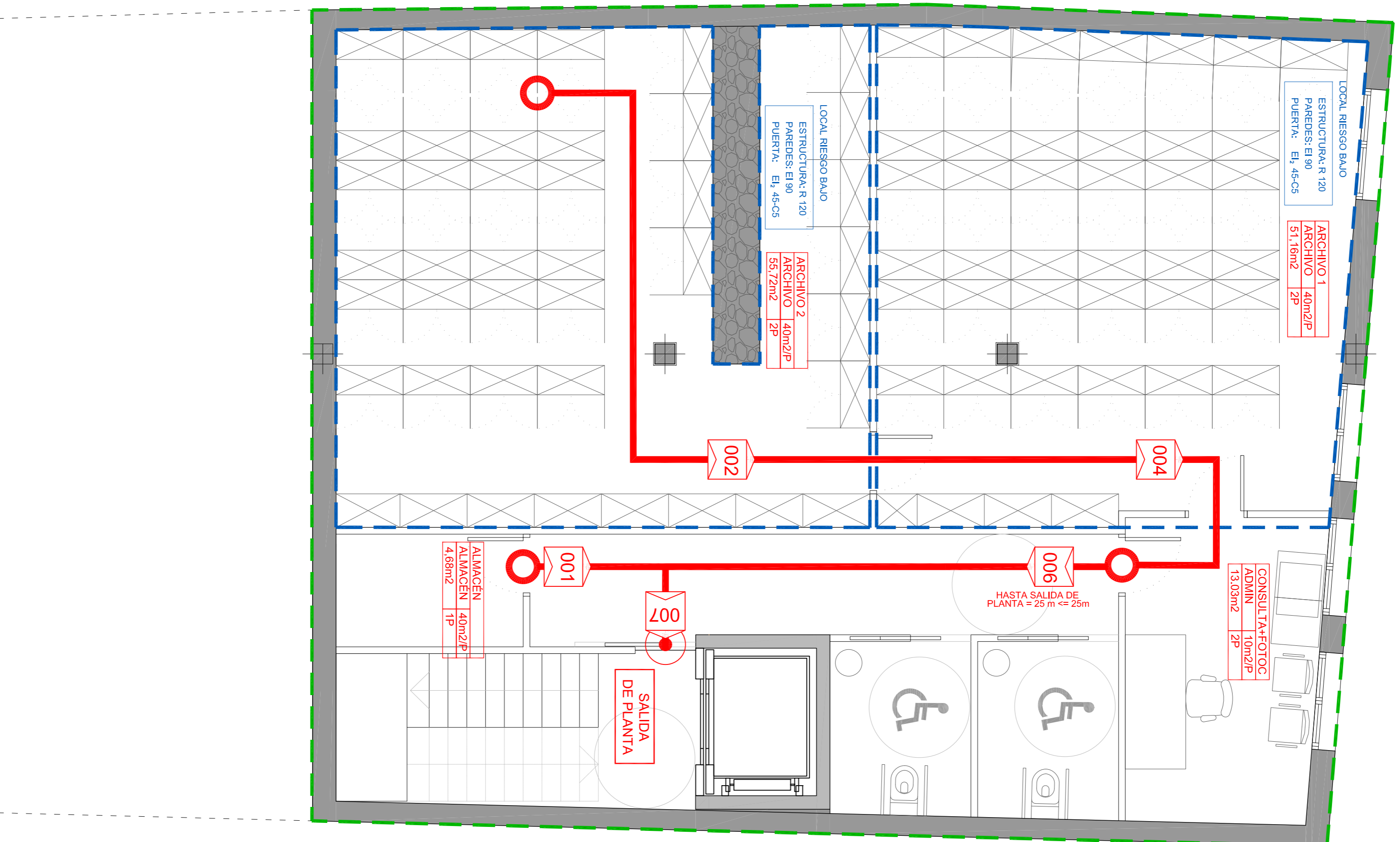

PLANTA SÓTANO

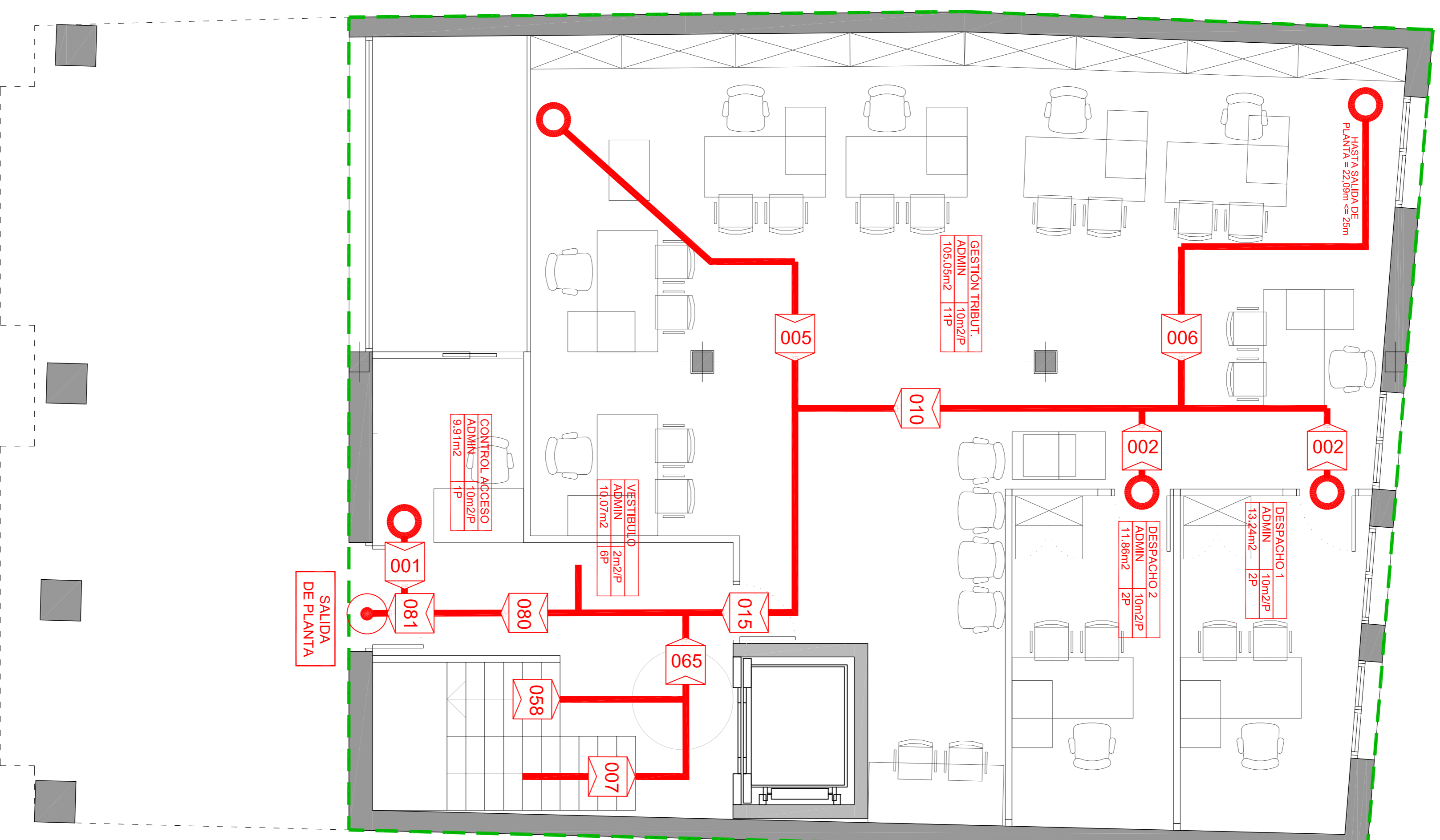

PLANTA BAJA



LEYENDA Y SIMBOLOGIA CTE DB-SI

-  USO, OCUPACION USO, SUPERFICIE UTIL Y OCUPACION
-  ORIGEN DE EVACUACION
-  RECORRIDO DE EVACUACION
-  SALIDA DE PLANTA/EDIFICIO

ZONA, TIPO DE ACTIVIDAD	
USO PREVISTO	RECEPCION
	PUB. CONC. 10m ² /P
	24m ² 3P
SUPERFICIE DEL LOCAL (M ²)	OCUPACION (M ² /P)
	Nº TOTAL PERSONAS

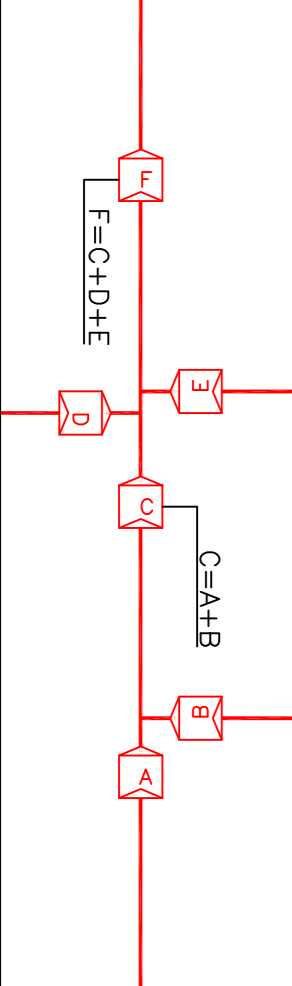



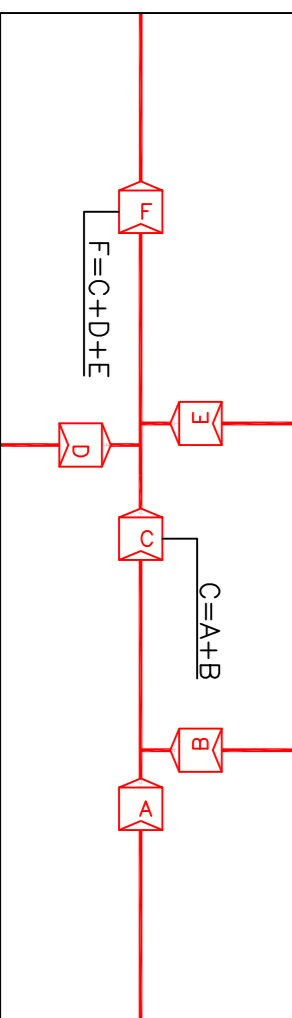
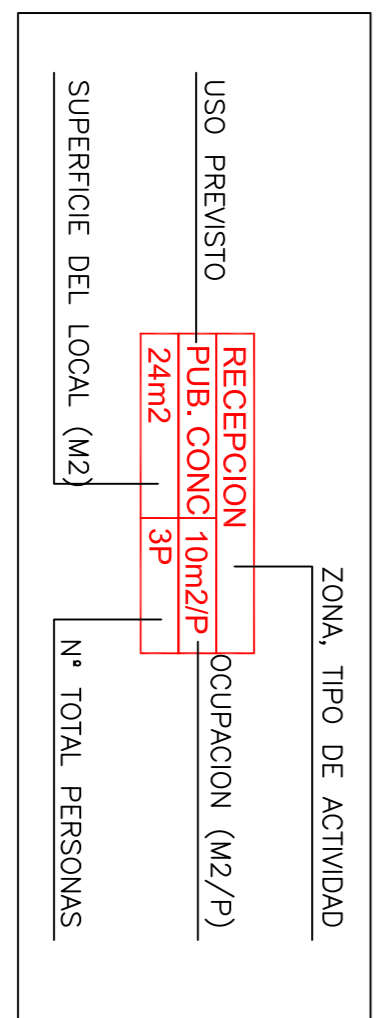
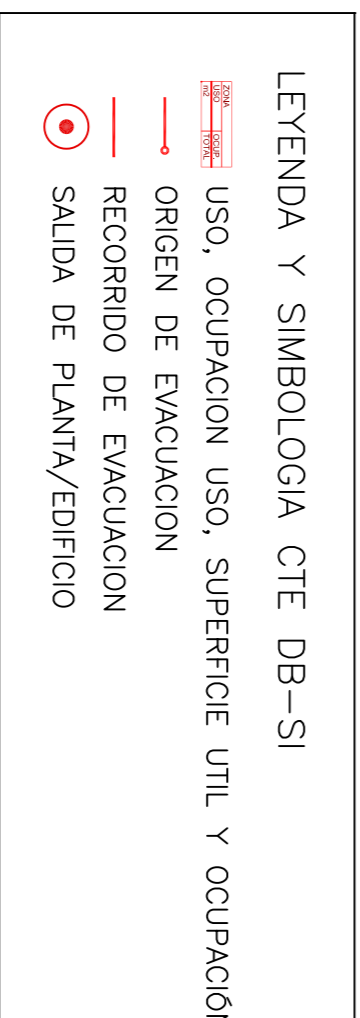
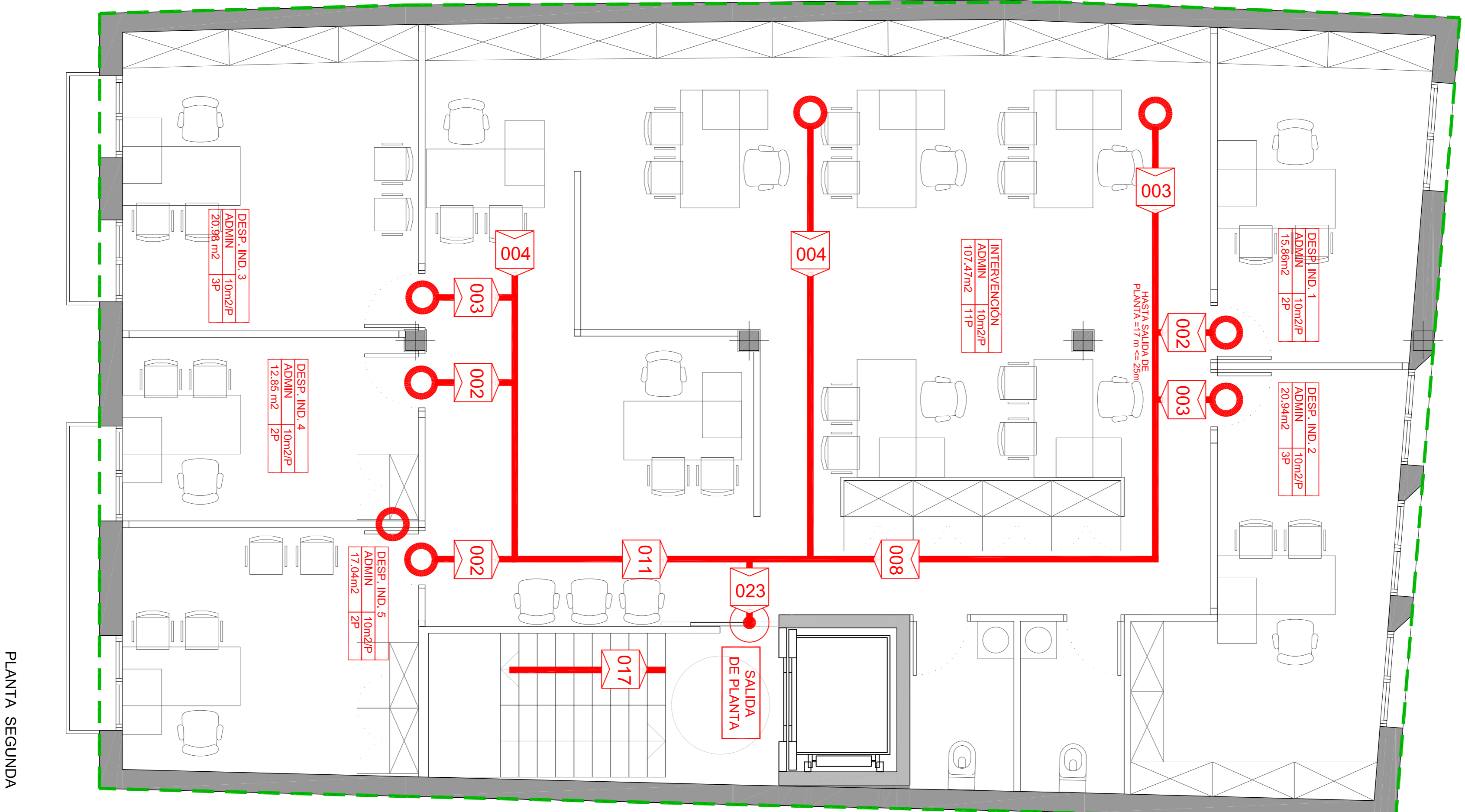
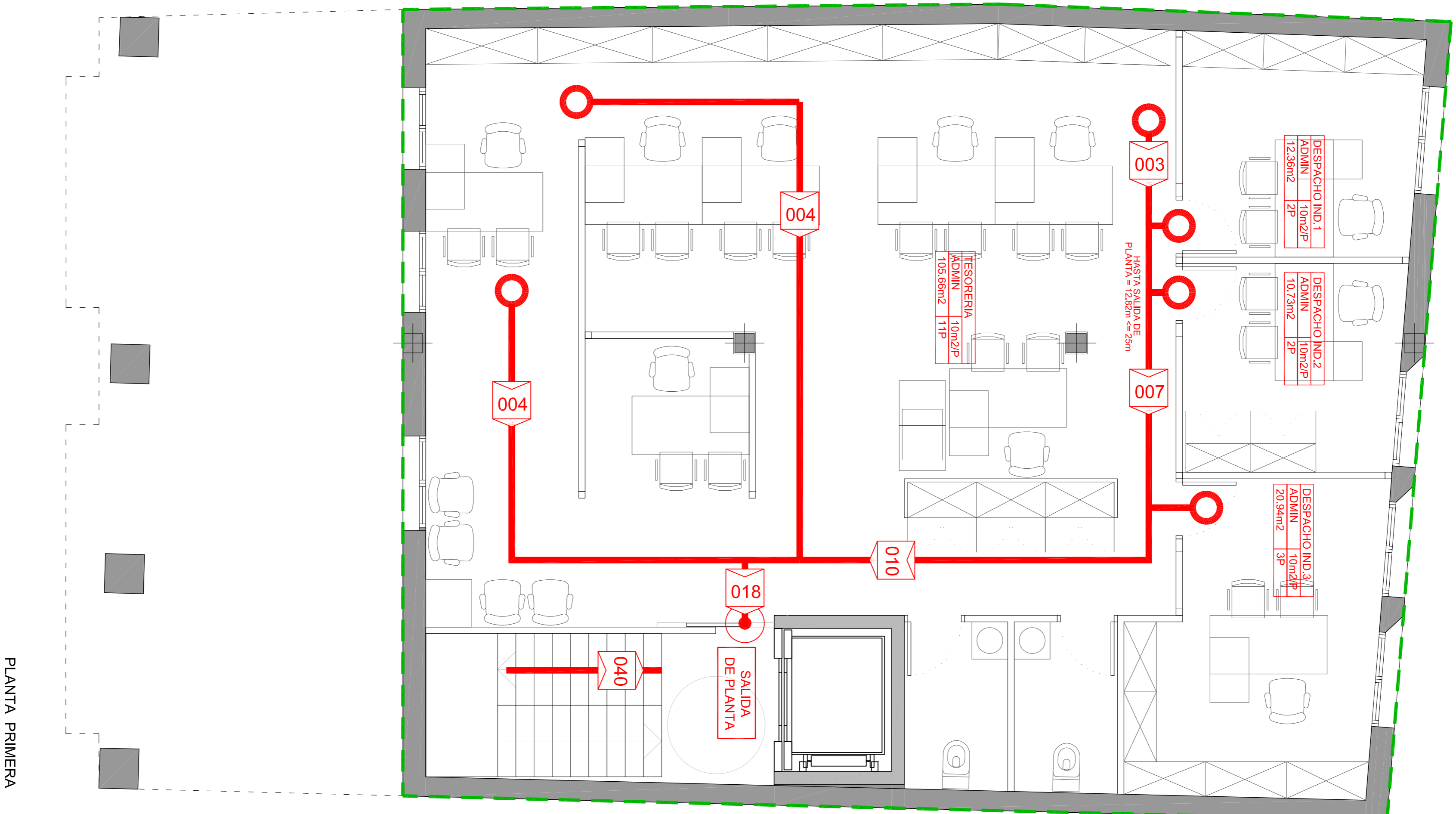

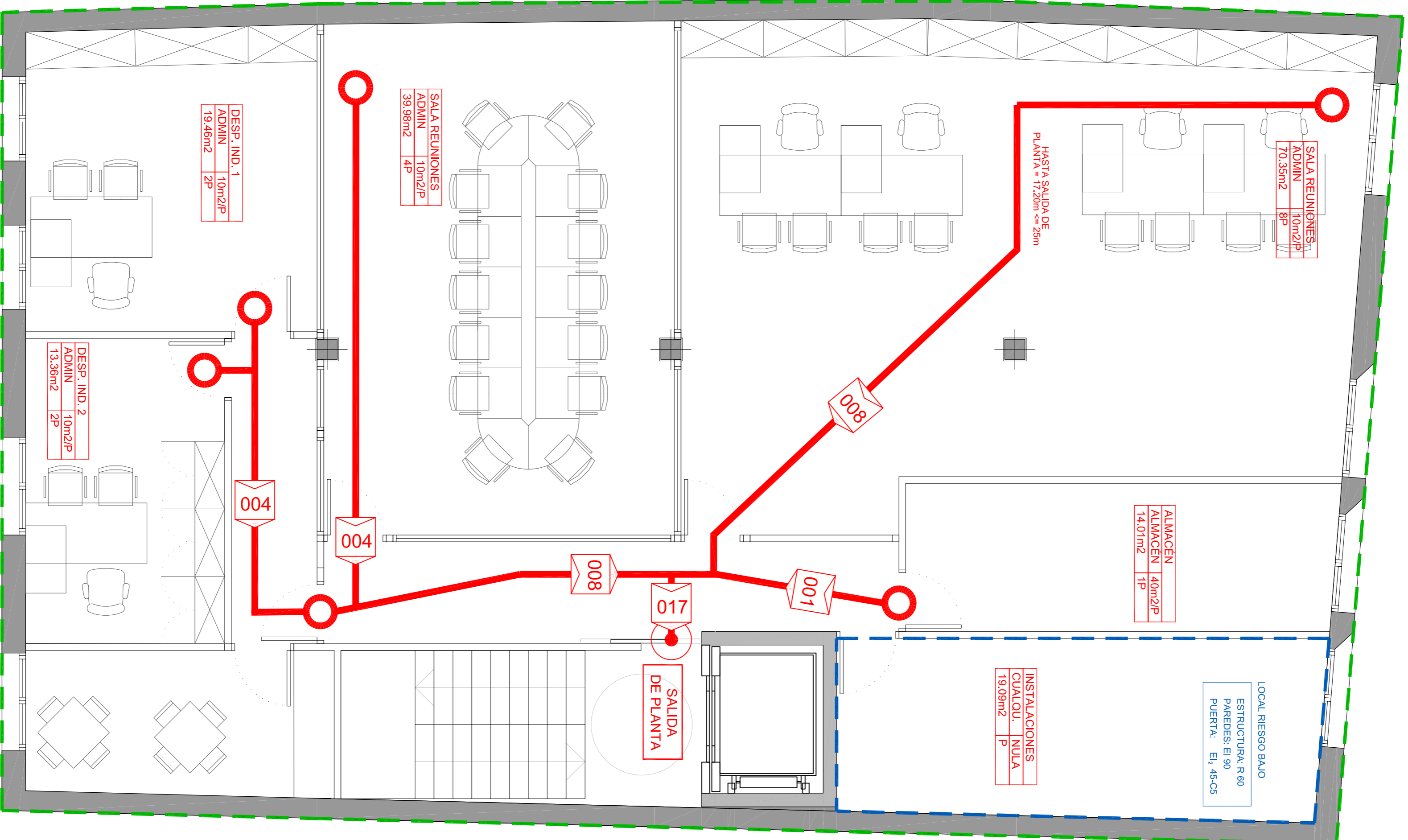
Nº PLANO:	6.1	TITULO DEL PLANO:	CUMPLIMIENTO CTE DB-SI P. SÓTANO Y P.BAJA
ESCALA:	DIN A1: 1/50 DIN A3: 1/100	FECHA:	MARZO 2018
FOTO: SCMA INGENIERIA Y MEDIOAMBIENTE		FOTO: SAN JUAN ARQUITECTURA S.L.	





PLANTA CUBIERTA

LEYENDA Y SIMBOLOGIA CTE DB-SI

-  USO, OCUPACION USO, SUPERFICIE UTIL Y OCUPACION
-  ORIGEN DE EVACUACION
-  RECORRIDO DE EVACUACION
-  SALIDA DE PLANTA/EDIFICIO

USO PREVISTO	RECEPCION	ZONA, TIPO DE ACTIVIDAD
PUB. CONC. 10m²/2p	3p	OCUPACION (M²/P)
24m²	3p	SUPERFICIE DEL LOCAL (M²)
		Nº TOTAL PERSONAS

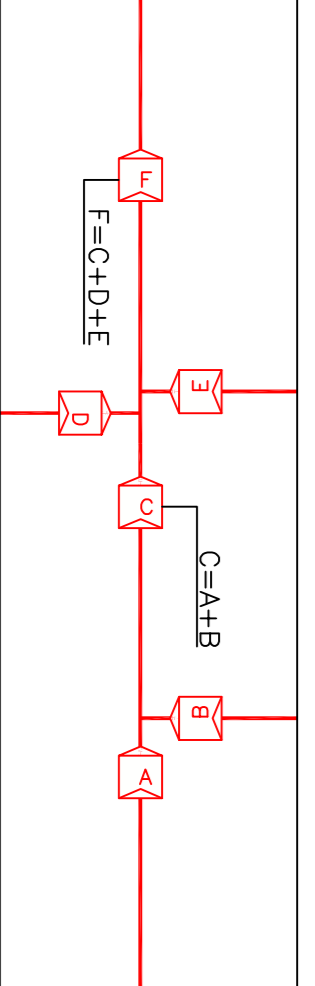

Nº PLANO: 6.3	TITULO DEL PLANO: CUMPLIMIENTO CTE DB-SI P. BAJO CUBIERTA Y P CUBIERTA
ESCALA: DIN A1: 1/50 DIN A3: 1/100	FECHA: MARZO 2018
	FIC: SAN JUAN ARQUITECTURA S.L.
	FIC: SCma INGENIERIA Y MEDIOAMBIENTE

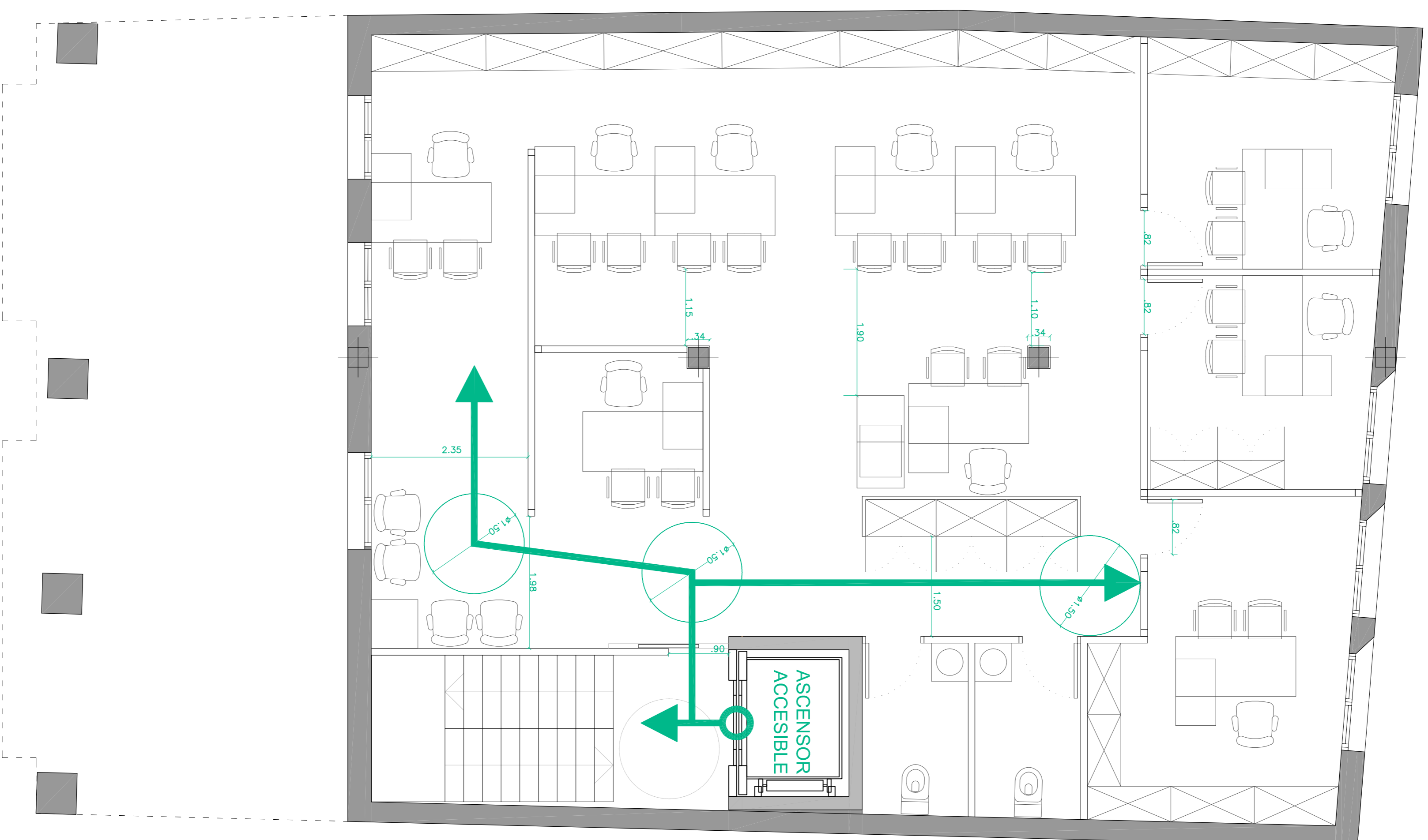

PLANTA PRIMERA

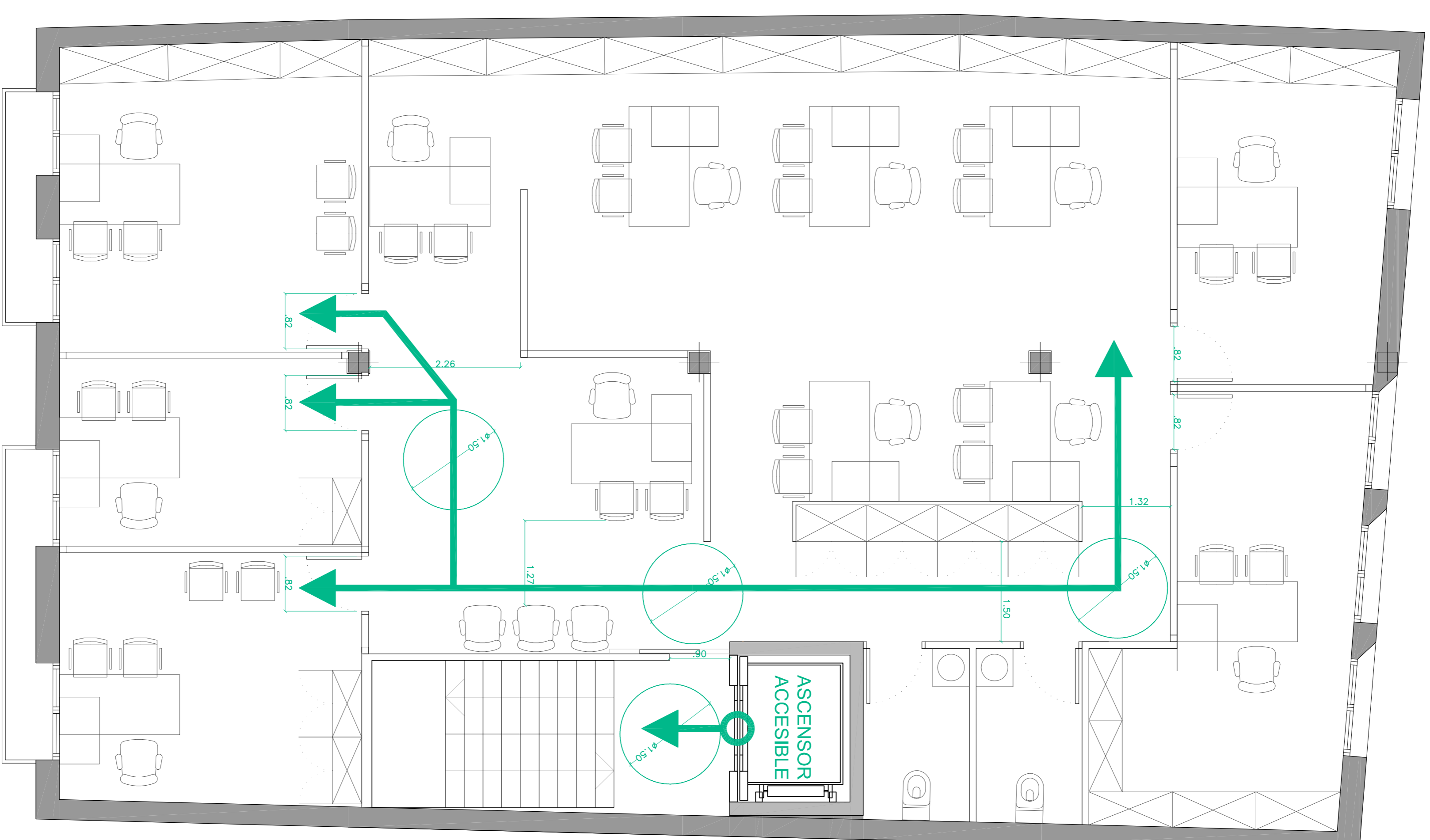

PLANTA SEGUNDA

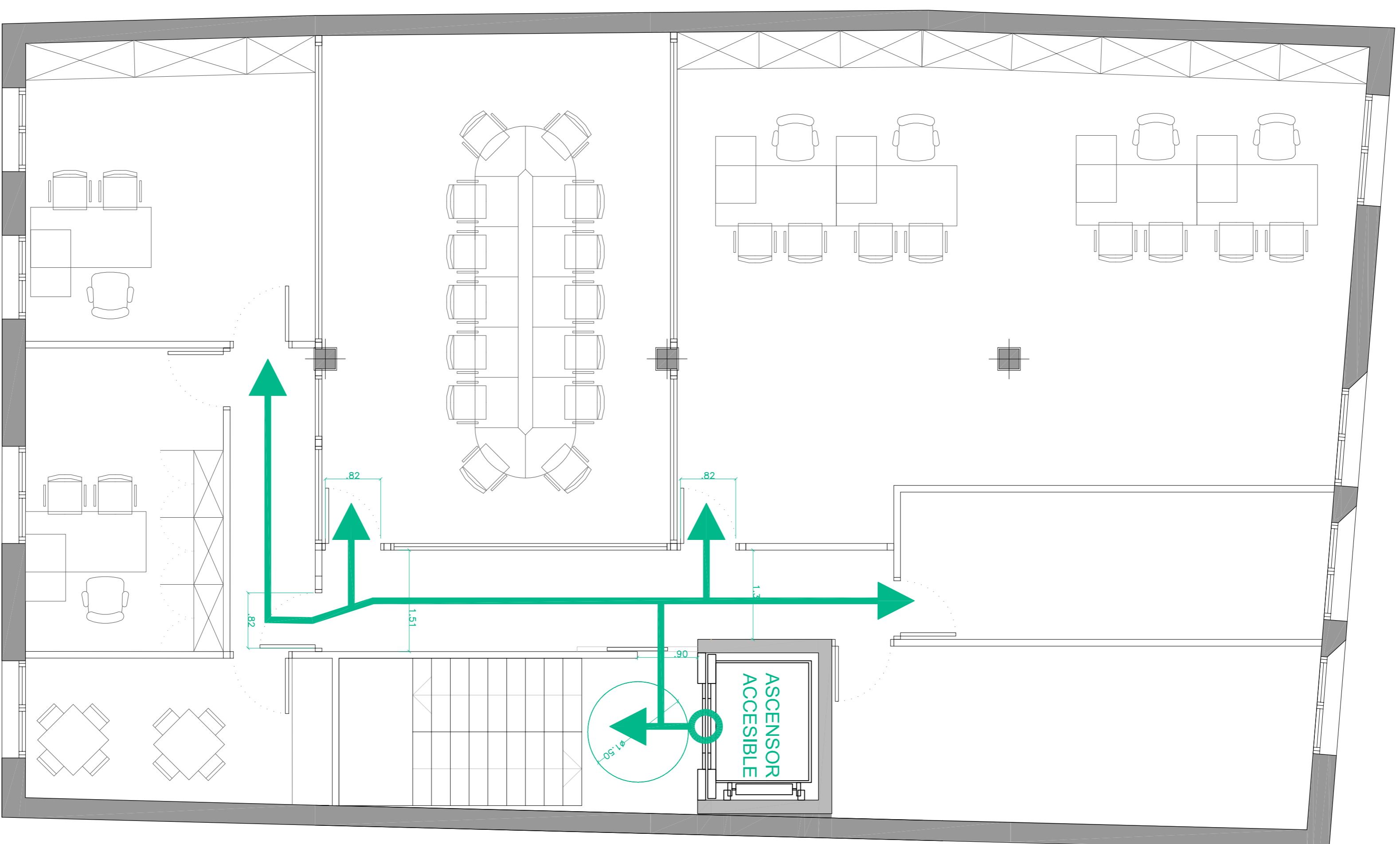

PLANTA CUBIERTA

Nº PLANO: 7.3	TÍTULO DEL PLANO: CUMPLIMIENTO CTE DB-SI P. BAJO CUBIERTA Y P CUBIERTA	FIC: SAN JUAN ARQUITECTURA S.L.
ESCALA: DIN A1: 1/50 DIN A3: 1/100	FECHA: MARZO 2018	FIC: SCma INGENIERIA Y MEDIOAMBIENTE